



AFRISO



Mess-, Regel- und
Überwachungsgeräte
für Haustechnik,
Industrie und Umweltschutz

Lindenstraße 20
DE-74363 Güglingen

Telefon +497135-102-0
Service +497135-102-211
Telefax +497135-102-147

info@afriso.de
www.afriso.de

Instruction Manual

Flue Gas Analysis Computer Type: BLUELYZER® ST

CAPBs®enabled



Read manual before use!



Observe all safety information!



Keep manual for future use!

Contents

1	About this instruction manual	5
1.1	Structure of warning	5
1.2	Explanation of symbols and typeface.....	5
2	Safety.....	6
2.1	Intended use.....	6
2.2	Predictable incorrect application	6
2.3	Safe handling	6
2.4	Qualification of personnel.....	7
2.5	Calibration	7
2.6	Modifications to the product	7
2.7	Usage of spare parts and accessories.....	7
2.8	Liability information.....	7
3	Product description.....	8
3.1	Properties and functions	8
3.2	Product contents	9
3.3	Measurement and calculation parameters	9
3.4	Measuring methods and Sensors	10
3.5	Technical specifications	11
3.6	Calculation formulae (extract)	13
3.7	Approvals, tests and conformities	14
4	Transportation and storage	15
5	Commissioning	16
5.1	Connection diagram	16
5.2	Use of the IR-printer.....	17
5.3	Use of the Bluetooth Smart printer.....	18
6	Operation	20
6.1	Menu structure V2.0.....	20
6.2	Measuring mode.....	24
6.3	Generate QR-CODE	29
6.4	Data Logger function (Option).....	29
6.5	"Fluegas measurement" program	31
6.6	"CO-Measurement" program.....	39
6.7	"Temperature measurement" program.....	42
6.8	"Pressure / Draft measurement" program (Option)	44
7	"Settings" configuration menu	48
7.1	Set Time / Date	49
7.2	Setting the display	49
7.3	Configure signals.....	50

7.4	Show device information	51
8	Memory mode & memory structure	52
8.1	Use of the memory	52
8.2	Database Memory (Option)	55
8.3	Enter the user's address	61
9	Battery management	63
9.1	Battery mode/charging mode	63
9.2	Charging the batteries	63
10	Maintenance	64
11	Troubleshooting	65
12	Shutting down and disposal	66
13	Spare parts and accessories	67
14	Warranty	67
15	Copyright	67
16	Customer satisfaction	68
17	Addresses	68
18	Appendix	69
18.1	DIN EN 50379 Certificate	69

1 About this instruction manual

This instruction manual is part of the product.

- ▶ Read this manual before using the product.
- ▶ Keep this manual during the entire service life of the product and always have it readily available for reference.
- ▶ Always hand this manual over to future owners or users of the product.

1.1 Structure of warning

WARNING TERM The type and source of danger is shown here.



- ▶ Precautions to take in order to avoid the danger are shown here.

There are three different levels of warning:

Warning term	Meaning
DANGER	Imminent danger! Failure to observe the information will result in death or serious injuries.
WARNING	Possible imminent danger! Failure to observe the information may result in death or serious injuries.
CAUTION	Dangerous situation! Failure to observe the information may result in minor or serious injuries as well as damage to property.

1.2 Explanation of symbols and typeface

Symbol	Meaning
<input checked="" type="checkbox"/>	Prerequisite for an activity
▶	Activity consisting of a single step
1.	Activity consisting of several steps
↵	Result of an activity
•	Bulleted list
Text	Indication on a display
Highlighting	Highlighting

2 Safety

2.1 Intended use

The flue gas analysis computer BLUELYZER® ST is exclusively suitable for:

- Professional settings and control measurements at all small combustion systems (low temperature and burner value boilers and thermal systems) for gas and oil systems.

Any use other than the application explicitly permitted in this instruction manual is not permitted.

2.2 Predictable incorrect application

The BLUELYZER® ST flue gas analysis computer must never be used in the following cases:

- Hazardous area (Ex)
If the device is operated in hazardous areas, sparks may cause deflagrations, fires or explosions
- Use as a safety (alarm) unit or continuous measuring device
- Ambient air monitoring
- Use in humans and animals

2.3 Safe handling

This product represents state-of-the-art technology and is made according to the pertinent safety regulations. Each device is subjected to a function and safety test prior to shipping.

- ▶ Operate this product when it is in perfect condition. Always observe the operating instructions, all pertinent local and national directives and guidelines as well as the applicable safety regulations and directives concerning the prevention of accidents.
- ▶ Perform an overall visual inspection of the measuring device (including any accessories) prior to each operation of the BLUELYZER® ST in order to ensure proper operation of the device.
- ▶ Protect the product against impact
- ▶ Use the product only indoor
- ▶ Insulate the product from moisture

WARNING



Severe burns or death due to voltaged parts.

- ▶ Do not touch voltaged parts with the instrument or sensors.

2.4 Qualification of personnel

The product may only be installed, commissioned, operated, maintained, shut down and disposed of by qualified, specially trained personnel.

Electrical work may only be carried out by qualified electricians in accordance with local and national regulations.

2.5 Calibration

The flue gas analysis computer BLUELYZER® ST have to be calibrated annually by a recognized, relevant authority.

2.6 Modifications to the product

Changes or modifications made to the product by unauthorised persons may lead to malfunctions and are prohibited for safety reasons.

2.7 Usage of spare parts and accessories

Usage of unsuitable spare parts and accessories may cause damage to the product.

- ▶ Use only the manufacturer's genuine spare parts and accessories of the manufacturer (refer to chapter 13, page 67).

2.8 Liability information

The manufacturer shall not be liable in any direct or consequential damage resulting from failure to observe the technical instructions, guidelines and recommendations.

The manufacturer or the sales company shall not be liable for costs or damages incurred by the user or by third parties in the use or application of this device, in particular in case of improper use of the device, misuse or malfunction of the connection, malfunction of the device or of connected devices. The manufacturer or the sales company shall not be liable for damage resulting from any use other than the use explicitly stated in this instruction manual.

The manufacturer shall not be liable for misprints.

3 Product description

The BLUELYZER® ST flue gas analysis computer is a multiple-function analyser with integrated calculating functions. Measurements are in accordance with the general regulations set forth by the German “BImSchV” at all kinds of combustion plants within the framework of the monitoring of exhaust systems.

The BLUELYZER® ST flue gas analysis computer has an infrared printer interface, a Bluetooth® interface (Bluetooth® low energy) and can be fitted with a memory card (MicroSD).

User-friendly, colour-coded menus support improved and intuitive operation. The individual measuring programs, configuration menus, etc. are assigned distinctive colours.

3.1 Properties and functions



1	Clear button / direct access
2	Up button
3	On/off button
4	Protective sleeve
5	Down button
6	Menu / Enter button
7	Display
8	Draft connection (Optional)
9	Speaker
10	USB power supply unit connection
11	IR-Printer-interface
12	MicroSD-cardholder
13	Gas connection
14	Flue gas temperature socket
15	Air temperature socket

3.2 Product contents

The Product contains: Flue gas analysis computer, protective sleeve with magnet, flue gas probe with gas treatment and condensate cartridge, air temperature sensor, replace filter, USB power-supply, calibration protocol, instruction manual.

3.3 Measurement and calculation parameters

Table 1: Measured Values

Value	Measured medium	Unit
Tgas	Flue gas temperature	°C, °F
Tamb	Air temperature	°C, °F
O ₂	Oxygen concentration	Vol. %
CO	Carbon monoxide concentration	ppm, mg/m ³ , mg/kWh, mg/MJ, Vol. %
Draft	Draft (option)	Pa, hPa, kPa, mbar, bar, mmWs, mmHg, inHg, Psi

Table 2: Calculated values

Value	Measured medium	Unit
CO ₂	Carbon dioxide	Vol. %
COref	Carbon monoxide referenced to an O ₂ reference value	ppm
Eta	Combustion efficiency value	%
Lambda	Excess air value	-
qA	Flue gas loss	%
Dewpnt	Fuel-specific dew point	°C, °F

3.4 Measuring methods and Sensors

Table 3: Measuring procedure

Function	Explanation
Temperature measurement	Thermocouple NiCr-Ni (type K)
O ₂ measurement	Electrochemical measuring cell
CO measurement	Electrochemical measuring cell
Draft (Option)	Piezo-resistive sensor with internal temperature compensation
Measuring duration	Short-term, stable measurements of max. 60 minutes are possible, followed by a new calibration phase with ambient air.
Flue gas measurement	Via an external water separator and filter, the flue gas is supplied to the sensors by means of a gas pump.
Sensor calibration	After switching on the instrument, there is a calibration phase that takes 30 seconds after a cold start.
CO Sensor protection	The standard CO sensor is protected automatically since the gas pump switches off when the maximum measuring range limit is reached (> 6000 ppm). The measurement starts again automatically when the sensor resets.
Flue gas sampling	Flue gas sampling is done by means of a probe which enables either a "one-point measurement" (combi probe) or a "multi-point measurement" (multi-hole probe).

WARNING



- ▶ The life of the sensors depends essentially on utilization and use of the instrument. The expected life of the gas sensors is about 24 months.

3.5 Technical specifications

Table 4: Device description

Parameter	Value
General Specifications	
Dimensions housing including protective sleeve (W x H x D)	67 x 37 x 144 mm (2,7 x 1,4 x 5,6 inch)
Weight (including protective sleeve)	Ca. 275 g (9.70 oz)
Material Protective sleeve	Plastic
Display	High-resolution graphical 2.8" TFT display (240 x 320).
Data communication	Infrared printer interface, Bluetooth® interface (Bluetooth® low energy).
Printer	External infrared thermal printer (EURO-printer)
Memory	Micro-SD memory card with folder/file structure
Temperature range	
Ambient	0 °C to +40 °C (+32 °F to +104 °F)
Medium	0 °C to +40 °C (+32 °F to +104 °F)
Storage	-20 °C to +50 °C (-4 °F to +122 °F)
Air pressure range	
Ambient	750 hPa to +1100 hPa
Humidity range	
Ambient	20 % rH to 80 % rH
Power supply	
Rechargeable battery	Lithium-Ion-Battery 3,6 V / 1800 mAh
Power adapter	USB power supply

Electrical guard	
Protection type	IP 42 EN 60529
Electromagnetic compatibility (EMC)	
Interference	DIN EN 55022 (VDE 0878-22)
Noise immunity	DIN EN 61000-4-3 (VDE 0847-4-3)
ESD	DIN EN 61000-4-2 (VDE 0847-4-2)

Table 5: Device specifications

Parameter	Value
Flue gas temperature measurement (T1 and T2)	
Measuring range	0 °C to +1000 °C
Max. deviation	± 1 °C (0 °C to +300 °C) ± 1.0 % of measured value (above +300 °C)
Resolution	0,1 °C
Sensor	Thermocouple NiCr-Ni (type K)
Combustion air temperature	
Measuring range	-20 °C to +200 °C
Max. deviation	± 3 °C + 1 digit (-20 °C to 0 °C) ± 1 °C + 1 digit (0 °C to +200 °C)
Resolution	0,1 °C
Sensor	Thermocouple NiCr-Ni (type K)
Draft measurement (Option)	
Measuring range	40 hPa
Max. deviation	± 2 Pa + 1 digit (<2,00 hPa) ± 1 % of measured value (>2,00 hPa)
Resolution	± 0,01 hPa respectively 1 Pa
Sensor	Semiconductor sensor

O ₂ -measurement	
Measuring range	0,0 Vol. % to 21,0 Vol. %
Max. deviation	± 0,2 Vol. % by volume of measured value
Resolution	0,1 Vol. %
Sensor	Electrochemical measuring cell
Response time (T90)	30 seconds
CO ₂ - determination	
Range	0 % to CO _{2,max} (fuel-specific)
Max. deviation	± 0.2 % by volume of measured value
Resolution	0.1 % by volume
Sensor	Calculation on the basis of measured O ₂ value
Response time (T90)	30 seconds
CO- measurement	
Measuring range	0 ppm to 2000 ppm (nominal) (6000 ppm max. displayed range)
Accuracy	5 ppm (to 50 ppm) 5 % of measured value (above 50 ppm)
Resolution	1 ppm
Sensor	Electrochemical measuring cell
Response time (T90)	60 seconds

3.6 Calculation formulae (extract)

Calculation of the CO₂ value

$$\text{CO}_2 = \text{CO}_{2,\text{max}} * \left(1 - \frac{\text{O}_2}{21}\right) \text{ in \%}$$

CO_{2,max} Max. CO₂ value (fuel-specific) in % by volume

O₂ Measured oxygen concentration in %

21 Oxygen concentration of the air in % by volume

Calculation of the flue gas loss

$$qA = (TG - TA) * \left(\frac{A_2}{21 - O_2} + B \right) \text{ in } \%$$

TG Flue gas temperature in °F or °C

TA Combustion air temperature in °F or °C

A2, B Fuel-specific factors

Calculation of the excess air value Lambda

$$\text{Lambda} = \frac{CO_{2\max}}{CO_2} = \frac{21}{21 - O_2}$$

Calculation of the combustion efficiency value (Eta)

$$\text{Eta} = 100 - qA \text{ in } \%$$

Calculation of CO reference (CO ref)

$$CO_{\text{ref}} = CO * \frac{21 - O_{2\text{ref}}}{21 - O_2}$$

CO_{ref} CO reference

O₂ Measured O₂ value

CO Measured CO value

O_{2ref} O₂ reference

3.7 Approvals, tests and conformities

The BLUELYZER® ST flue gas analysis computer is approved in accordance with the German "1. BundesImmissionsSchutzVerordnung" (1. BImSchV) and EN 50379-2, is TÜV-tested and meets the applicable directives of 2014/30/EU.

4 Transportation and storage

CAUTION Damage to the device due to improper transportation.



- ▶ Do not throw or drop the device.
 - ▶ Transporting the device only in the device-specific case.
-

CAUTION Damage to the device due to improper storage.



- ▶ Protect the device from shock when storing it.
 - ▶ Store the device in a clean and dry environment.
 - ▶ Only store the device within the permissible temperature range.
 - ▶ Store the device away from paint, solvent and glue.
-

5 Commissioning

WARNING



▶ Before using the BLUELYZER® ST you have to do a visual inspection of the entire measurement equipment (Device and accessories). For a correct operation of the device.

5.1 Connection diagram

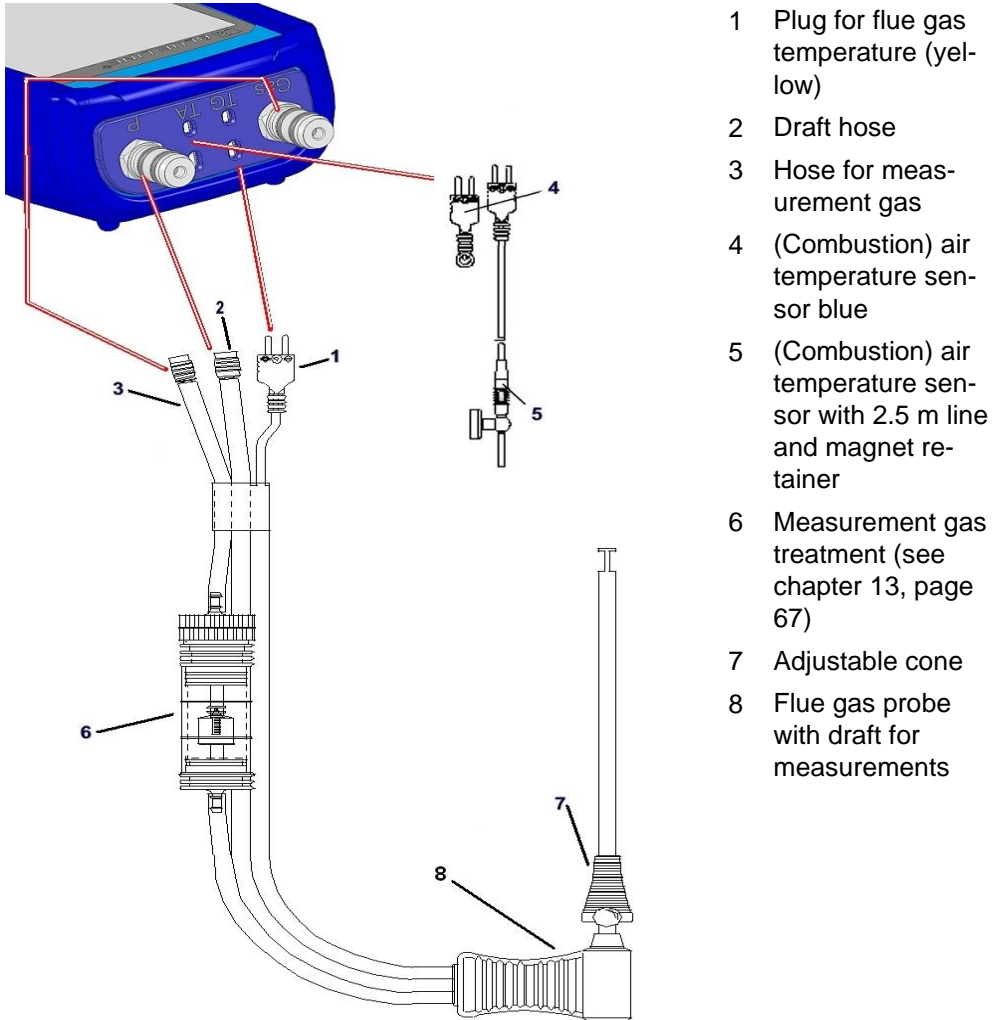
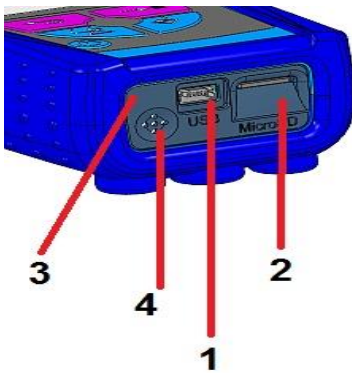

Fig. 1: Connection diagram (Sensor side)



- 1 USB power supply unit
(100-240 V / 50-60 Hz)
- 2 MicroSD-card holder
- 3 IR-Printer-interface (not shown)
- 4 Speaker

Fig. 2: Connection diagram (Interface side)

5.2 Use of the IR-printer

Note: For printing, the IR interface of the BLUELYZER® ST unit must point towards the printer as shown in the following illustration, keeping a minimal distance of ca. 25 cm! (Max. ca. 70 cm).



Fig. 3: Positioning of the BLUELYZER® ST towards the printer

WARNING Transmission errors if positioning is not correct



- ▶ The optical transmission zone must be kept straight and free of obstacles!

5.3 Use of the Bluetooth Smart printer

Measuring Data could be also transferred via Bluetooth Smart to the “EUROprinter-BLE”. Activate the Bluetooth Smart in the BLUELYZER® ST Settings and on the printer. To activate the Bluetooth Smart on the printer press the buttons “OFF” and “ON” at once. A blue flashing LED means activated Bluetooth Smart otherwise the IR modulus is activated. The Bluetooth Smart connection between device and printer is described below:



Select the detected printer to activate the printer.

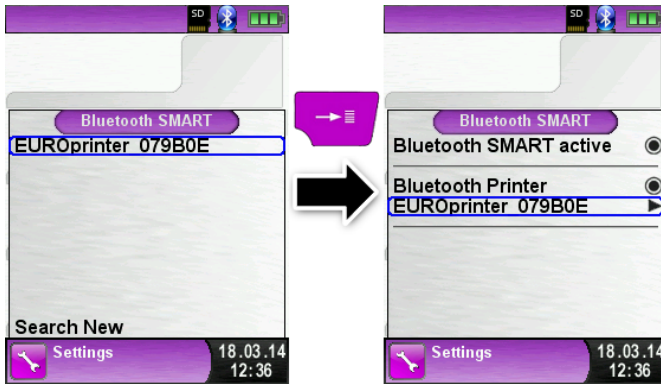

The IR modus could be set by deactivating the „Bluetooth Printer“ in the settings menu. Set the printer to IR modus as well. Press the buttons „OFF“ and „ON“ at once and the blue flashing LED goes out.

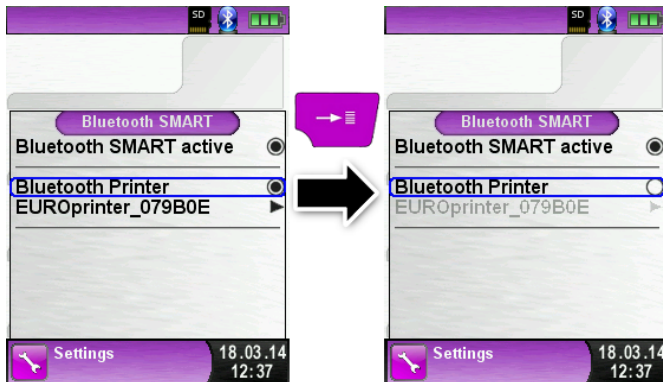

6 Operation

Switch on device: Briefly press the  button.

6.1 Menu structure V2.0

From the firmware V2.0 a new main menu structure is available. The menu is divided in different lists: Favourites, Internal, Wireless and System. Switch with the “back arrow” button between the different menu lists.

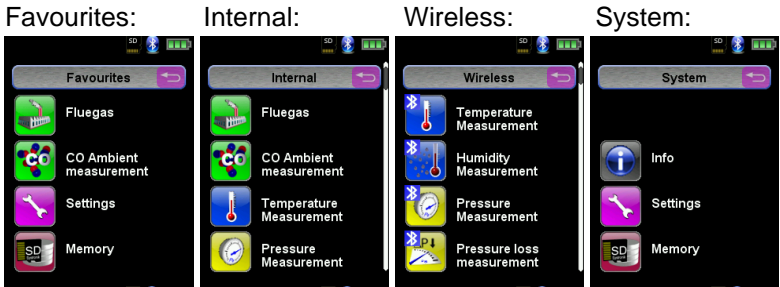

Menu Favourites: On new devices a default favourites list is available. Measuring programs from the lists Internal, Wireless and System can be activated for the Favourites list. New Favourites programs will occur at the end of the list. Set of factory settings won't change the favourites list. Set of factory setting with an empty favourites list, will set the default favourites list.

Menu Internal: In this list are all measuring program which access to the internal sensors.

Menu Wireless: In this list are all measuring program which connect to the CAPBs.

Menu System: In this list are all System information.

Edit Favourites list

In every measuring program in the settings menu is the menu item “In favourites”. If this item is activated the program will occur in the favourites list. Otherwise this program isn't available in the favourites list.

CAPBs product description

CAPBs are measuring instruments for different applications. CAPBs can be used to extend BlueLine measuring instruments by the measured variables provided by the CAPBs. The BlueLine measuring instrument or an app on a smartphone or tablet display, evaluate and log the measured values. The measured values are transferred via Bluetooth Smart technology.

The following BlueLine measuring instruments can be paired with the CAPBs: BLUELYZER ST, EUROLYZER STx, MULTILYZER STe, S4600 ST series and TMD9.

The various CAPBs allow you to measure pressure, differential pressure, flow, temperature and humidity. There are CAPBs for detecting gas leaks and CAPBs to measure air quality.

CAPBs are modular. This way, various sensor modules can be connected via different connection types. This results in numerous application solutions.

Overview



1	LED
2	Multi-purpose button
3	Magnets
4	Unlocking mechanism for removing CAPBs sens
5	Battery compartment
6	Snap-in mechanism for CAPBs sens

LED display

LED status	Meaning
Flashing blue	CAPBs is searching for a Bluetooth Smart connection
Flashing green	CAPBs is connected
Flashing yellow	Measuring mode
Flashing white	Measurement finished – measured data available
Flashing magenta	Data logger active
Flashing red	Sensor error
Flashing red, fast	CAPBs connected, no CAPBs sens plugged in
Flashing magenta, fast	CAPBs not connected and no CAPBs sens plugged in

Modular system with base handle STm

The CAPBs constitute a modular system consisting of the universal base handle CAPBs STm and an application-specific sensor module CAPBs sens for a wide variety of measured variables.

The base handle CAPBs STm holds the various sensor modules CAPBs sens. The base handle can be combined with any sensor module to form a complete CAPBs measuring unit. A multi-purpose button is located at the front; it is used for switching the unit on and off, for zero adjustment, for activating the Hold mode or for starting the data logger function. The multi-colour LED displays the status of the CAPBs measuring unit by means of different colours and flashing frequencies.

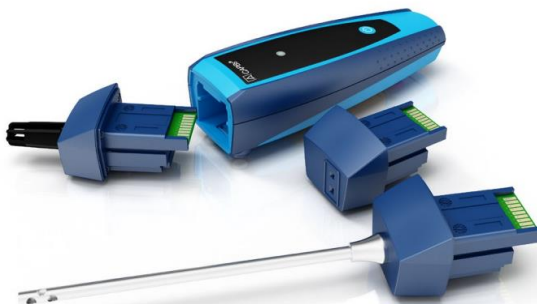

Operation with BlueLine devices

Initial commissioning

1. For switching on, press and hold down for two seconds the multi-purpose button of the CAPBs device.
2. Start the required CAPBs program on the measuring instrument, designated by the Bluetooth symbol .
3. Press the "Enter" button to open the main menu in the measurement program.
4. Select the Bluetooth Smart search for CAPBs under "Settings → Bluetooth SMART".

The Bluetooth Smart search takes approximately 30 seconds. The CAPBs must be on while the search is running. The CAPBs devices found are displayed with serial number of the base handle and the designation of the CAPBs sens.

5. Select the required CAPBs and press the "Enter" button to establish the connection.

When the connection is established, the colour of the LED at the CAPBs LED changes from blue to green. The selected CAPBs is now paired with the BlueLine device. In the future, it will connect automatically. It is sufficient to switch on the CAPBs before you start the required measurement program on the BlueLine device.

CAPBs settings

You can assign a function to the button of the multi-purpose button of the CAPBs via the menu item "Settings → Bluetooth SMART → CAPBs Button". The following functions are available (depending on the measurement program): Start/Stop, Hold, Zero, Reset Max/Min and Data Logger (option).

In the Direct Access menu, you can switch between different CAPBs devices via the menu item "CAPB".

6.2 Measuring mode

Program selection

The program selection area represents the available programs as icons. There you can select programs with the arrow buttons and start them with the „Menu/Enter“-button.

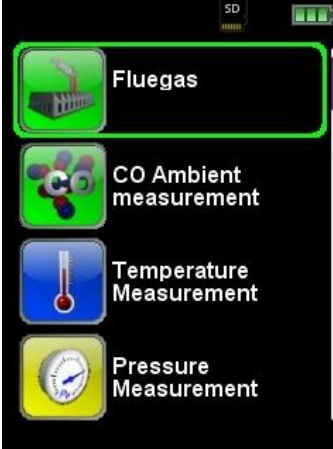

Fig 4: Program selection in the start menu, (ex.: Flue gas measurement)

Main Display

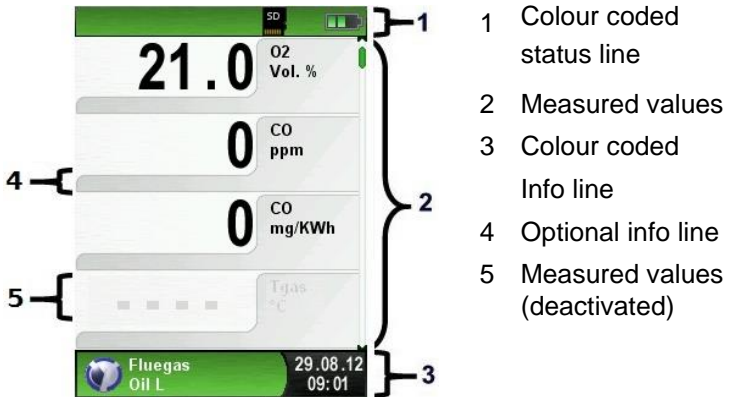









Fig. 5: Display showing measuring program (e.g. flue gas analysis)

Status line

The status line shows the status of relevant program information such as remaining battery power, Hold-function, Print-function, Bluetooth®-function and operating of the MicroSD-card. The information displayed depends on the mode and function-specific criteria.

Symbol	Bedeutung
	MicroSD card in the device
	Status battery
	Active Bluetooth Smart connection
	Inactive Bluetooth Smart connection
	Measuring data sending to the EUROprinter
	Status CAPBs battery
	CAPBs searching
	Flue gas temperature lower than dew point temperature

Information line

The information line provides details on the time and date, chosen fuel, service messages, etc.

Optional info line

The optional info line gives additional Information about the corresponding measured values, ex.: CO₂max-values, Min- and Max-values etc.

Measured values (deactivated)

In an unconnected or inactive sensor measuring the corresponding measurement value is displayed in gray.

Main Display

► Activate the Main Display with the „Menu-/Enter“-Button.

The Main Display include the main functions of the device.

All other functions respectively settings, are in additional submenus.

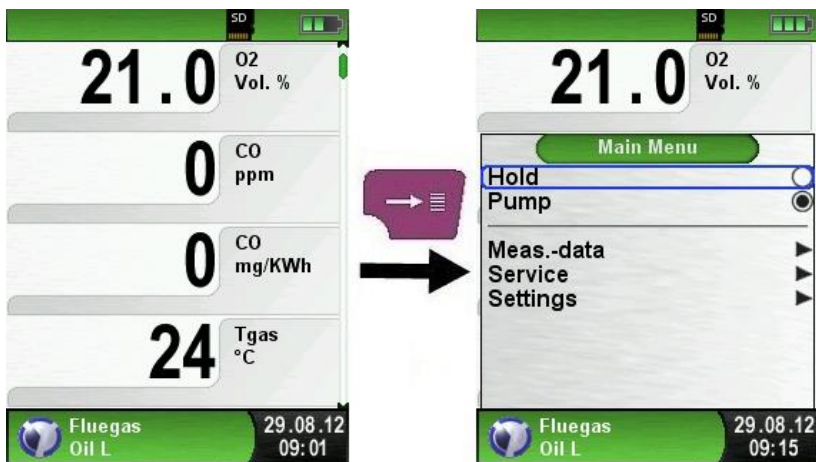

Direct access menu

- Print the measured values or Quit Measurement.

Press the "Clear" button to show the direct access menu. The captured values may be either printed or saved in a report on the MicroSD card (option). Furthermore you can deactivate HOLD- or stop the measurement and return to the Start menu.

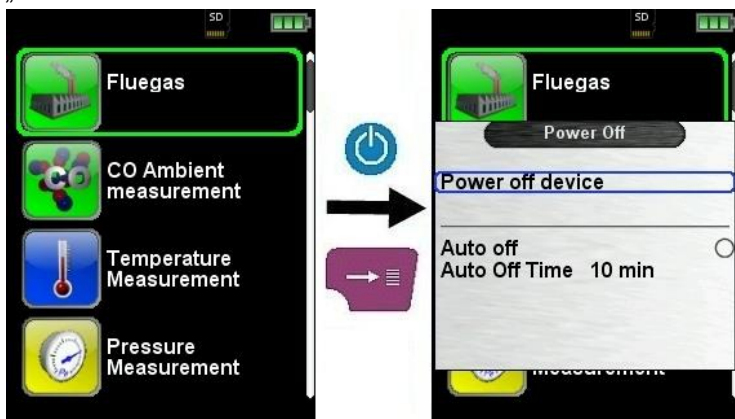

Fig 6: Direct access menu, (ex.: Flue gas measuring)

As soon as the print command is chosen, the record is printed parallel to the measuring task (→ multitasking function), i.e. the measurement mode remains active.

- Switch off the device.

Briefly press the „On-/Off“-button  and confirm with the „Menu/Enter“-Button.



Editor

The editor modus is used in different sub menus to set different values, as example: interval time in Data Logger function.

► Set interval time in Data Logger function

To change the interval time select “Interval” and start the modification with the “Enter” button. With the “arrow buttons” change the value. To get a zero set “---”. Begin to set the first number.

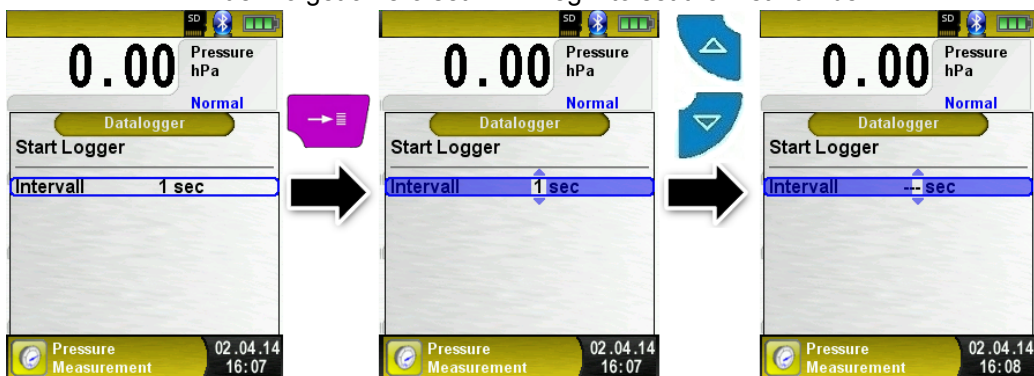

Then confirm with the “Enter” button and set the second number.
Again confirm with “Enter” button and finally set the third number.
Confirm the number with “Enter” button.



6.3 Generate QR-CODE.

With the QR-Code the measured values could be transferred to a Tablet or Smartphone.

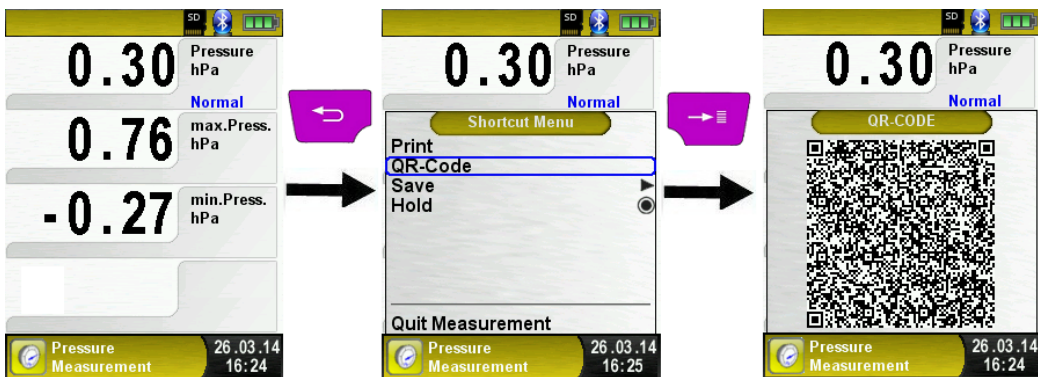

6.4 Data Logger function (Option)

- ▶ Start Data Logger function.

The function „Data Logger“ is available in different measuring program in the main menu. The Data Logger will be explained in the pressure menu. Without MicroSD card the Data Logger will not start. The MicroSD card is important to store the logged values.

Open the main menu with the “Enter” button and navigate to “Data Logger” and confirm with “Enter” button.

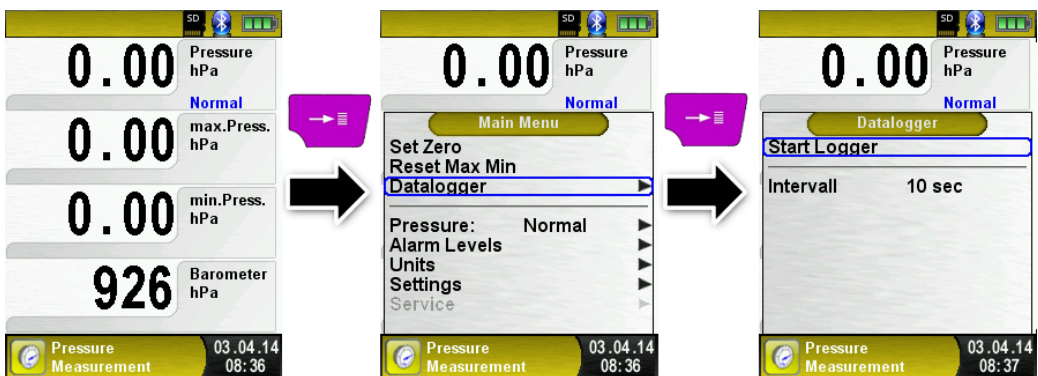

Start the Data Logger with the “Enter” button on “Start Logger”. In the lower field of information the time progress of the logger is shown.

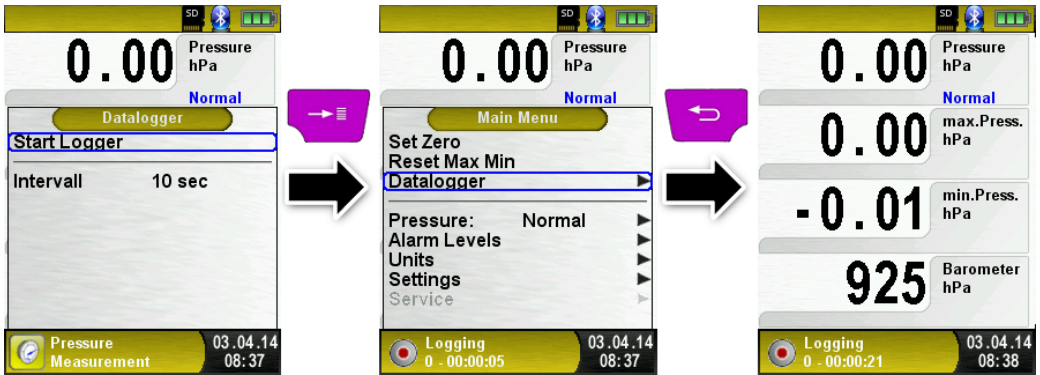

Stop the Data Logger with the “Enter” button on “Stop Logger”.

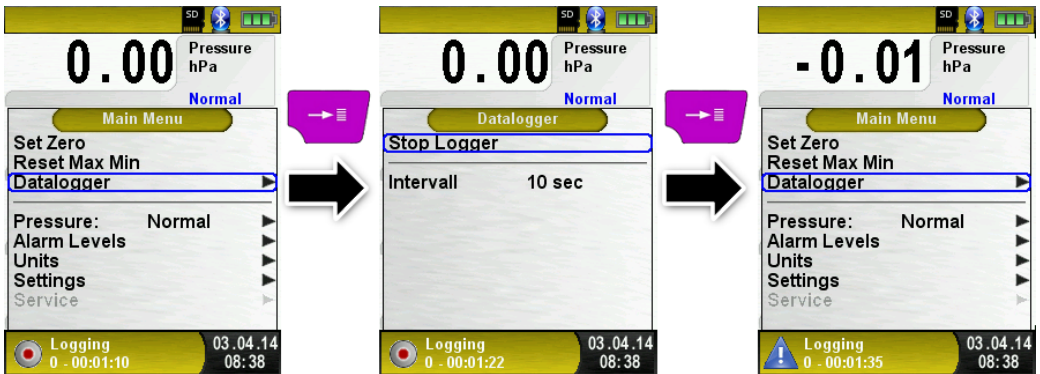

The logged values will be stored on the MicroSD card in the folder „LOGGER\Date. File name is the starting time. Every 7200 lines the device will automatically create a new XLM log file. With a logger interval of 1 second and a 1 GB MicroSD card it is possible to log in minimum a time period of 2 months.

6.5 "Fluegas measurement" program

- ▶ Start the "Fluegas" program.
(menu colour: green)

After a cold start the calibration phase takes 30 seconds.

After calibration the last fuel used is selected by default and displayed for confirmation with the "Enter-Button", another fuel can be selected with the navigation buttons and can be confirmed with the "Enter-Button".



- ▶ Switch gas pump off or back on.



When the gas pump is switched off, the pump symbol is no longer shown in the status bar. Changes in the corresponding measured gas values cannot be ruled out, e.g. the O2 value may change as a result of lack of oxygen in the gas lines inside the device. If the gas pump remains off for a longer period of time, calibration in fresh air should be carried out before a new measurement is made.

► Print measurement record (measured values stored with HOLD)



Measured values in HOLD mode can be checked prior to printing. It is also possible to print values recorded in HOLD mode at a later point of time.

As soon as the print command is chosen, the record is printed parallel to the measuring task (→ multitasking function), i.e. the measurement mode remains active.

► Perform draft measurement (Optional)

To determine the zero point (= initial value in relation to the ambient air pressure), the air hose (with the blue connector) must be unplugged before each draft measurement. After this, the zero point can be readjusted in case of a deviation from "0.00 hPa". Reconnect the draft hose for measurement and complete the measurement.



The measured draft is displayed continuously in the main display (red coloured). After the confirmation of the draft value with "Include Draft" the value will be included in the record and will be displayed in black colour.

Note: Only a draft value displayed in black colour will be available for printing or saving in a protocol!



► Reorder values

The function “Reorder values” can be selected as shown in the following pictures.



Navigate with the “Arrow”-buttons to the desired value and select with the “Enter”-button. The value indicated by a different color.

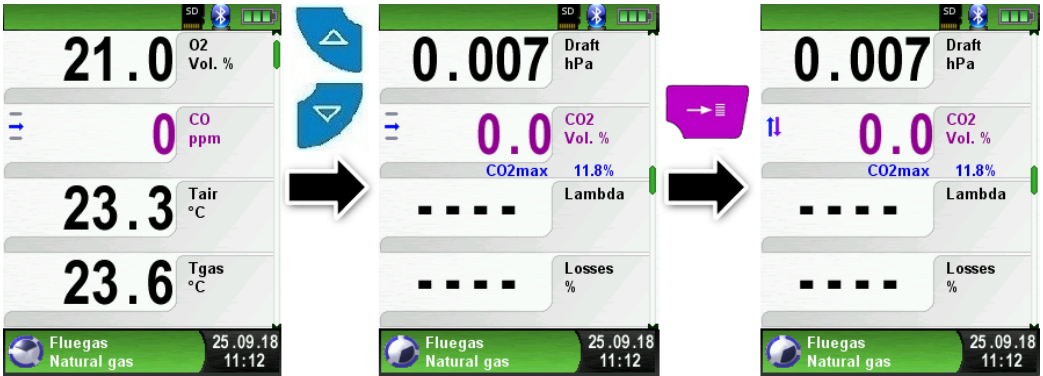

With the “Arrow”-buttons the value can be shifted to the desired position. The position can be saved with the “Clear”-button and the value is indicated in black again.



► Change units.

The units of draft, temperature and gas can be changed as shown in the following pictures.



► Change O2 Reference.

The desired O2 reference may be changed, as seen on the following images.



► Entering the boiler temperature.

The desired boiler temperature may be changed, as seen on the following images.



► Entering the Smoke No.

The desired Smoke No. may be changed, as seen on the following images.



6.6 "CO-Measurement" program

The BLUELYZER® ST is not intended for safety-related measurements!

WARNING







- ▶ (Power on the device) calibration only in fresh, pollutant- and CO-free ambient, meaning outside of the measurement site!
- ▶ In case of harmful concentrations of CO immediately take appropriate measures: Leave the danger area, ventilation respectively provide fresh air, warn endangered people, shut off heater, fix the trouble professionally, etc.

- ▶ Start the „CO- Measurement “ program.
(menu colour: green)

After a cold start the calibration phase takes 30 seconds, then the CO-Measurement is automatically started.



Taste	Function
	Cancel measuring program and return to start menu / Display Direct-Menu.
	Scroll through the menu line by line.
	Display start menu.
	Switch off device.

If the CO-Value exceeds one of the limits the speaker signals it with an alarm sound. Values exceeding the second limit are displayed in red.

Example:

1. Limit : 50 ppm (Only alarm-sound)
2. Limit : 100 ppm (Alarm-sound and red displayed values)

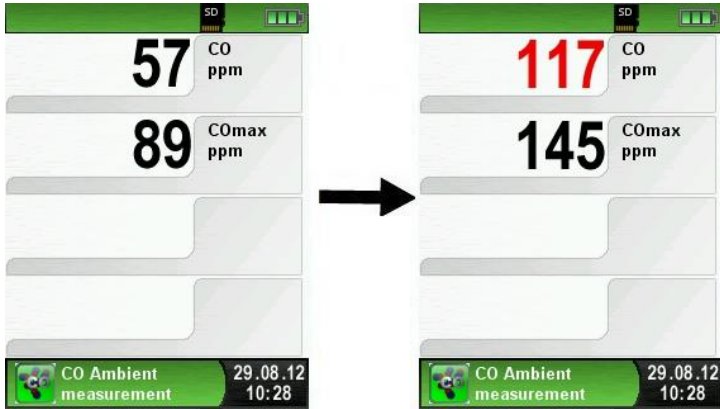

► Reset the COmax-value.



► Configure limit value.

The required limit value can be configured within the respective (nominal) measuring range on a user-specific basis.

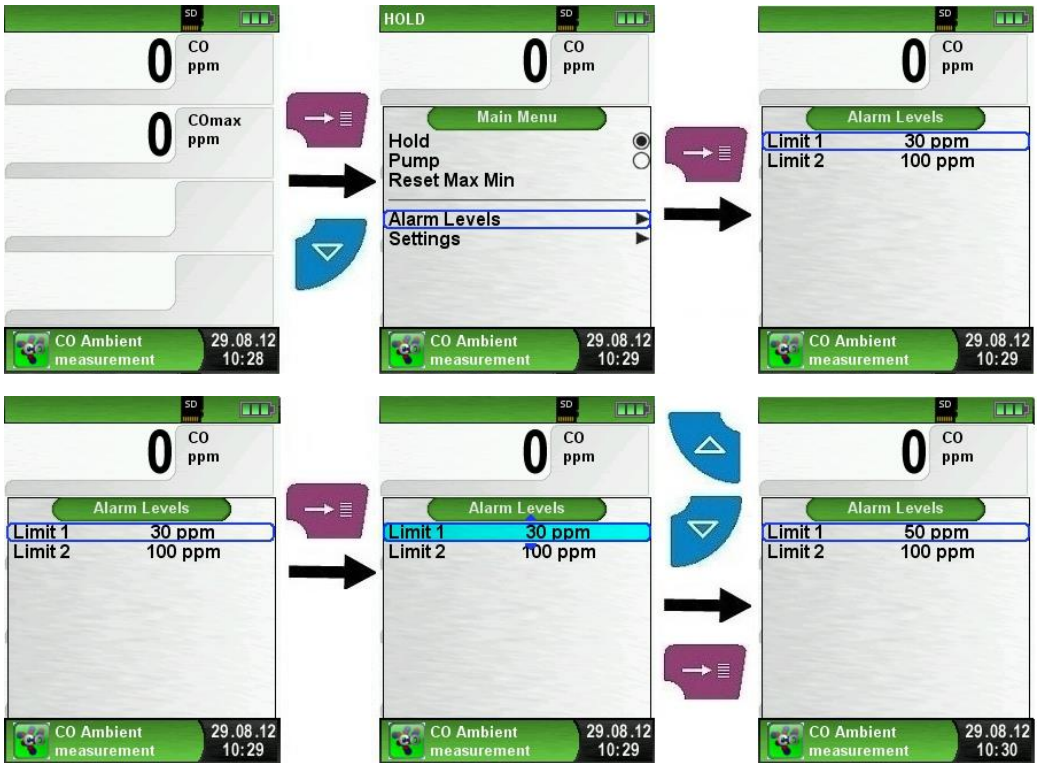

6.7 "Temperature measurement" program

- ▶ Start "Temperature" program.
(menu-colour: Blue)

After the start of the program „Temperature“ the measured temperature values and the resulting differential temperature and Min-/ Max-values are shown on the display.

From the main menu you can clear the minimum and maximum values or change the temperature unit.

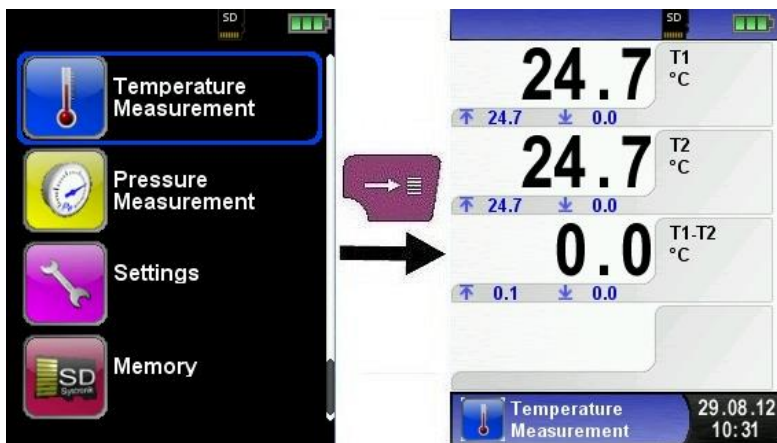

- ▶ Reset the Min- and Max-values.



► Change the temperature unit.



► Print / save protocol, quit measurement.

When you press the "Clear" button the direct access menu appears. The captured values may be either printed or saved in a report on the MicroSD card (option).

Furthermore you can deactivate HOLD- or stop the measurement and return to the Start menu.

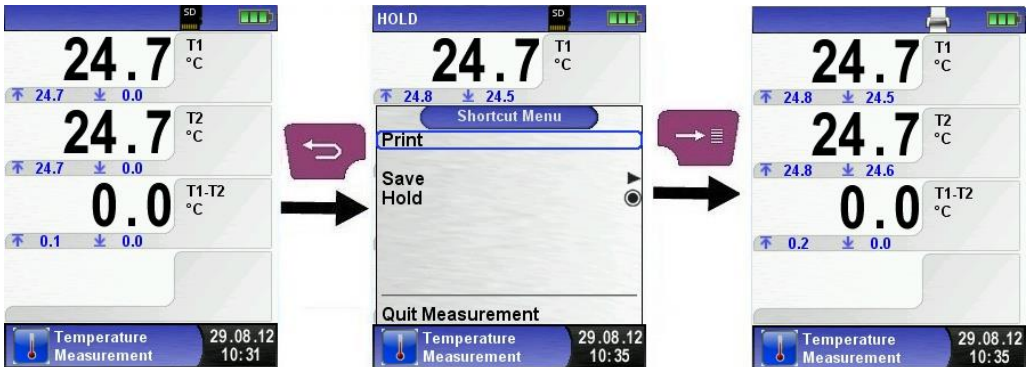





6.8 "Pressure / Draft measurement" program (Option)

- ▶ Start "Pressure" program.
(menu colour: yellow)

After starting the program, "Pressure Measurement" at first the automatic zeroing of the pressure sensor will occur, the zeroing phase lasts a few seconds.

After the zeroing, the font of the pressure value changes from gray to black. The black text signals the preparedness of the measuring device. The zeroing of the pressure value can also be run manually from the main menu.



Taste	Function
	Cancel measuring program and return to start menu / Display Direct-Menu.
	Scroll through the menu line by line.
	Display start menu.
	Switch off device.

► Reset Min- und Max- value



► Speed of the pressure measurement

The speed of the pressure measurement can be changed in the main menu, you may choose between the settings "normal" and "fast". When set to "fast" the measurement is performed at double speed.



► Changing the units

For the pressure measurement there are different units to choose from, as shown in the following illustration.

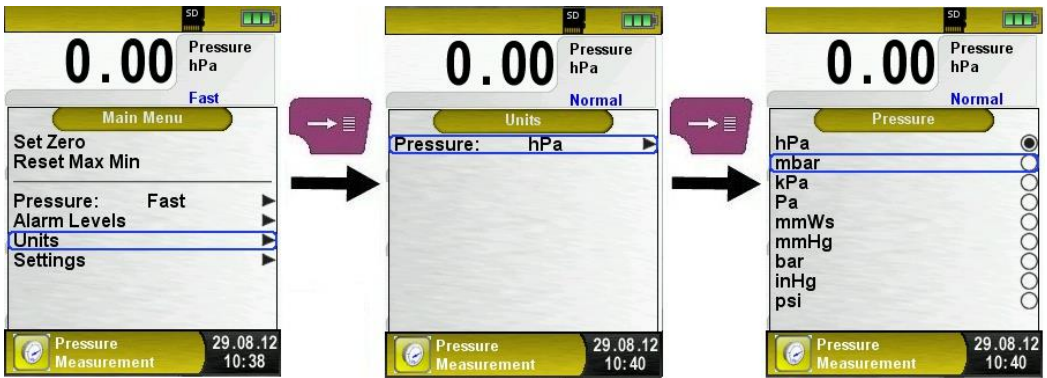

► Print measurement respectively end measurement.

After pressing the "Clear" button, the Direct Access menu appears. The captured values may be either printed or saved in a report on the MicroSD card (option).

Furthermore, you can disable the HOLD function or stop the measurement and return to the Start menu.



As soon as the print command is chosen, the record is printed parallel to the measuring task (→multitasking function), i.e. the measurement mode remains active.

► Configure limit value.

The required limit value can be configured within the respective (nominal) measuring range on a user-specific basis.

If the pressure value exceeds one of the limits the speaker signals it with an alarm sound and the values are displayed in red.



7 "Settings" configuration menu

- ▶ Open "SETTINGS" configuration menu.
(menu colour: purple)

The configuration menu "Settings" can be accessed from the Start menu and in the main menu of the individual measuring programs.

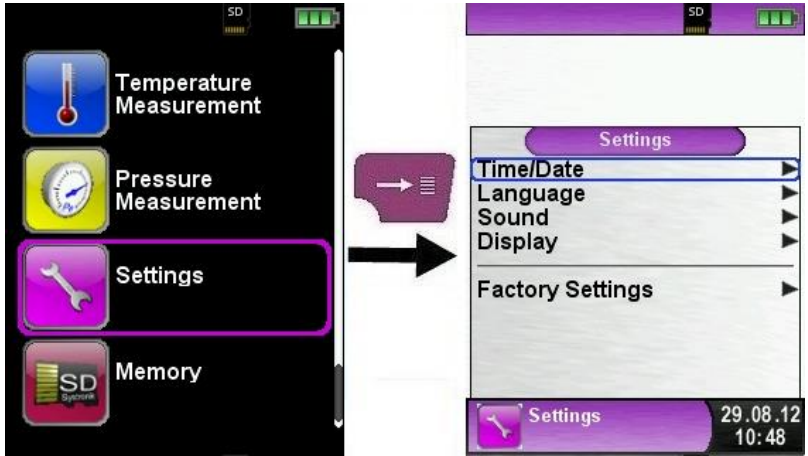

Fig 7: „Settings“ configuration menu in start menu



Fig 8: „Settings“ configuration menu in main menu, (ex.: Flue gas measurement)

7.1 Set Time / Date

- ▶ Time / date setting change.

For example, to change the month, select the month-line with the arrow buttons and confirm with the "Menu / Enter" button. The blue line indicates that you can now change the value using the arrow buttons, use the "Menu / Enter" button to confirm. The device can handle leap years and summer-/wintertime.



7.2 Setting the display

The intelligent power management of BLUELYZER® ST optimises the battery life.

The device provides three display settings: "Normal", "Automatic" and "Eco Mode". The selected setting influences the battery life, see chapter 9.1, page 63

- ▶ Change the display setting.



7.3 Configure signals

► Configure Button Sound and Alarm sound.

There are four sound levels for the touch tone and the alarm tone:

1. Off
2. Low
3. Mean
4. Loud

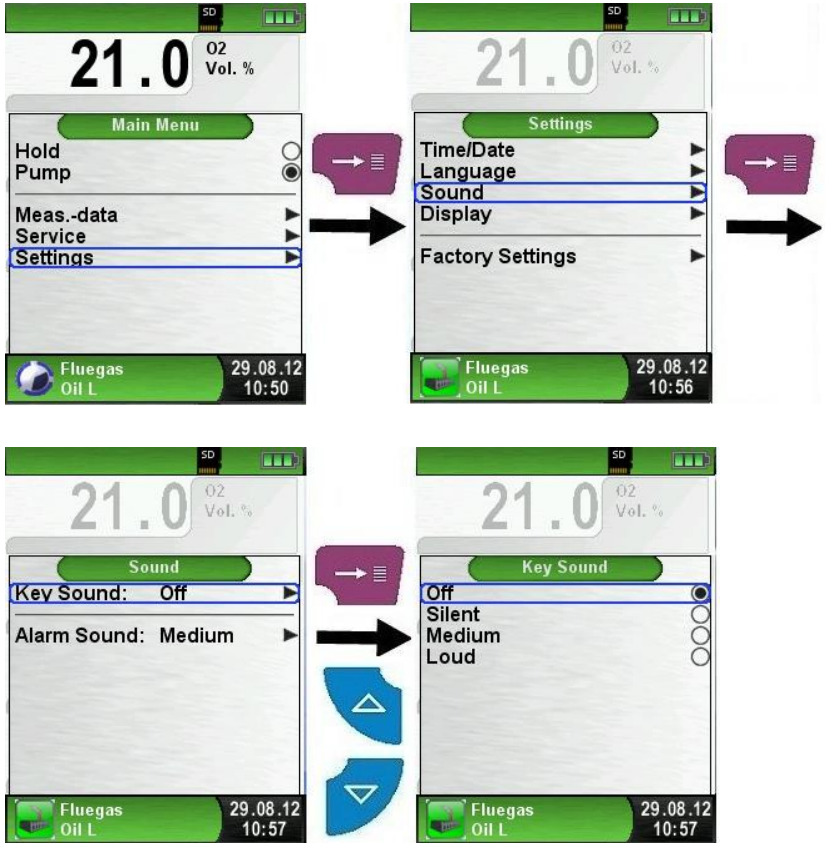

7.4 Show device information

► Show Info-data.

To show device pending Info-data press the „Enter“-button in the start menu on the „Info“ program. In the „Info“ menu following data will be displayed: Firmware-Version, Release-Date and Serial-Nr.

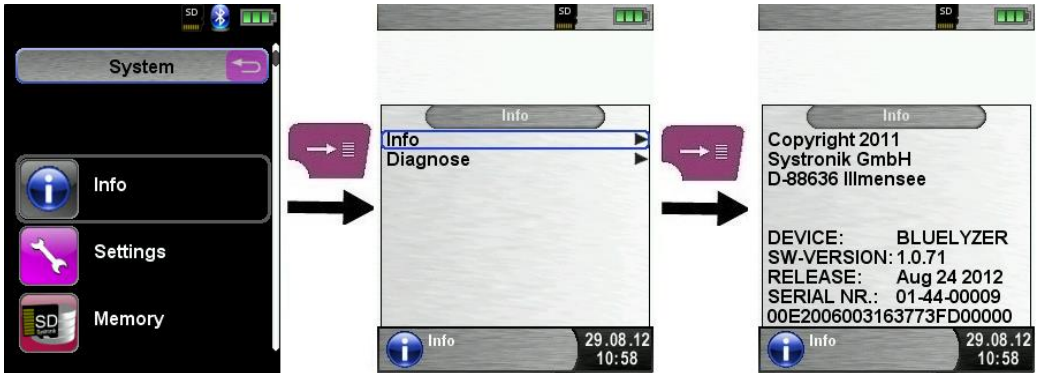

► Show Diagnose-data.

To show Diagnose-data press the „Enter“-button in the start menu on the „Info“ program. In the „Diagnose“ menu following parameters will be displayed:

Battery-voltage, Power-supply-voltage, battery-temperature (in charging mode) and System/Status-code.



8 Memory mode & memory structure

8.1 Use of the memory

The use of Micro-SD memory cards as system-independent storage media ensures maximum flexibility in terms of storing and handling the measured data. The card can be read without any additional software by all SD-card-enabled data processing systems (PCs, laptops, notebooks, etc.) using a web browser.



CAUTION Damage to the MicroSD card slot due to improper use.



- ▶ Insert the MicroSD card in the device with the contacts showing up, as shown in the figure.
- ▶ Display "Memory" menu.
(menu-colour: dark red)

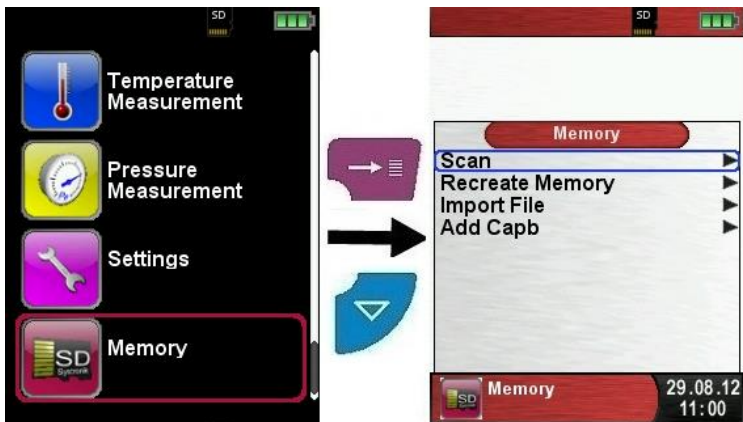

- ▶ Before the first use of a MicroSD card, the memory structure should be created.

The procedure „Recreate Memory“ creates 10 folders with 10 files on the MicroSD-card, this represents the memory structure of the flue gas analysis computer BLUELYZER® ST. The procedure takes a few seconds.

Note: An existing memory structure is erased! Private user files (e.g.: photos, documents, etc.) are not deleted during this procedure.

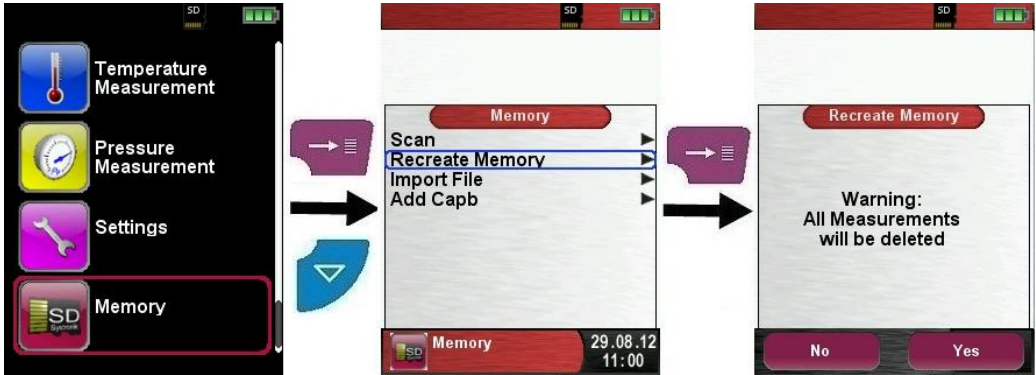

- ▶ The memory structure consists of 100 memory locations, which can be described in each case with a measuring protocol.

At the end of a measurement you can take the measurement protocol in a free space. There are 10 x 10 memory locations available. The file name is automatically assigned by the device and is structured as follows:

Fluegas 26.05.12-08:41

Type of measurement (ex.: Fluegas) Date and time

Note:

A file which has been created and saved on the card is protected against manipulation and, if manipulated, can neither be displayed by the device nor printed!

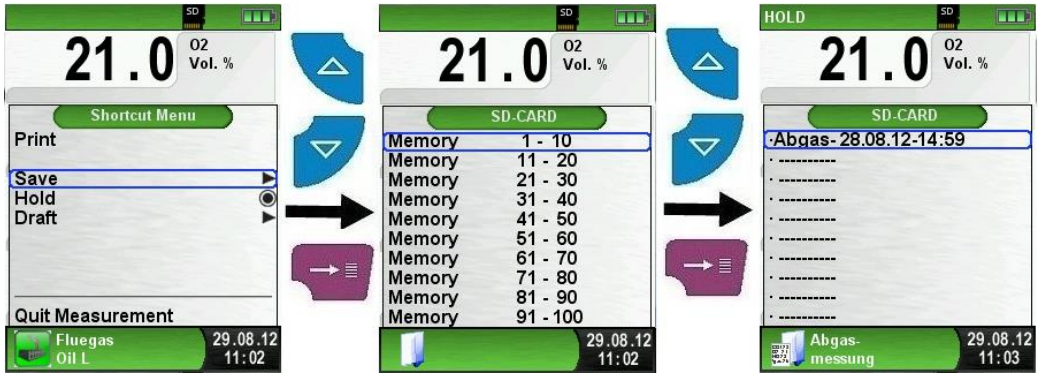

You can view the saved file, print or override it with a new measurement.



The saved file can be opened with a web browser (ex Mozilla Firefox).

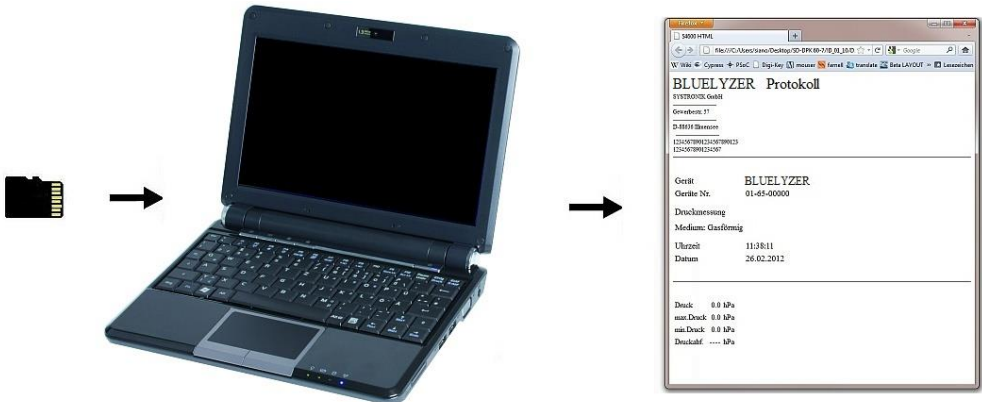

8.2 Database Memory (Option)

► Create a customer database

Measurements can be saved direct in the customer folder. Every folder has 8 entry lines with 20 characters. The first entry is the key word for the search function in the device. The further lines are for detailed customer information like: Street, City, Email, Phone No... The customer information will be print out with every measurement print and shown in the protocol.

It is possible to create or modify the customer database either on the BLUELYZER® ST or on a PC.

► For first use of the MicroSD card the database should be generated

For new database open menu „Memory“ and choose “Create Database”. Confirm the warning “All entries will be deleted” with yes.

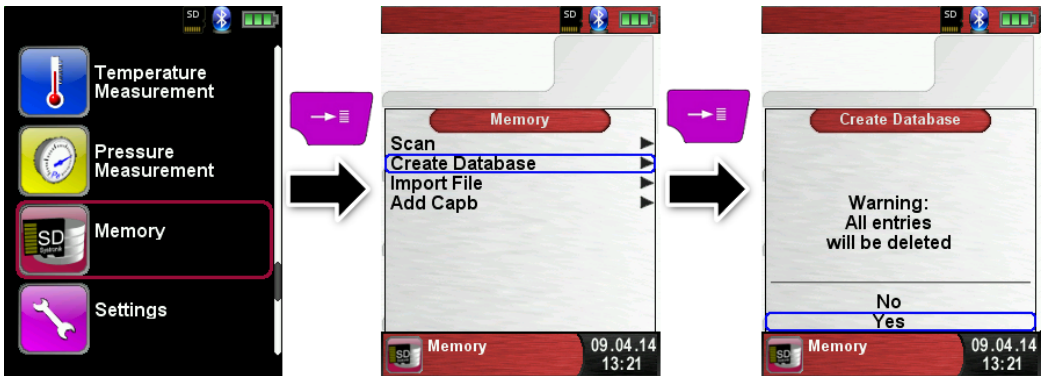

With this procedure a file named DATABASE.CSV will be generated on the MicroSD card. This file will show the database entries of the BLUELYZER® ST. This process needs a few seconds.

CAUTION



- Existing Database will be deleted! Private files (images, documents etc.) won't be deleted!

- ▶ Create / modify customer database on the BLUELYZER® ST
Select „Scan“ in the menu „Memory“ and type the customer name:

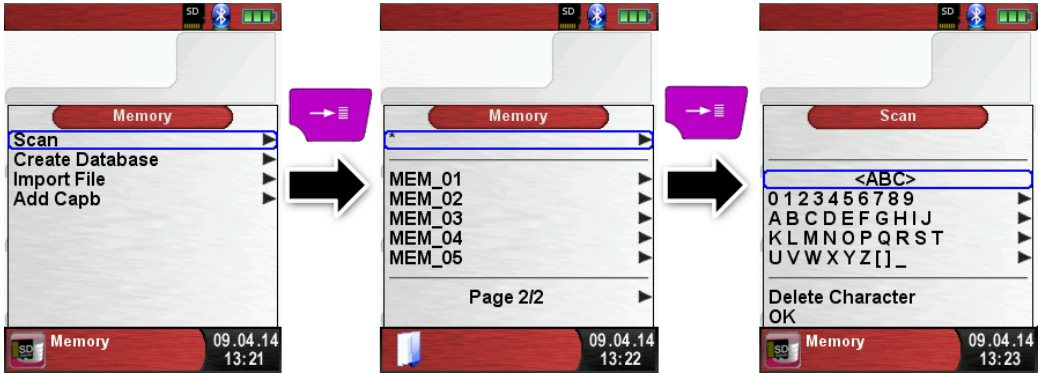

- Select with the arrow buttons the row with the desired character.
Open the row with the „enter button“ and select the desired character using the arrow buttons. Select letter by letter in this way:

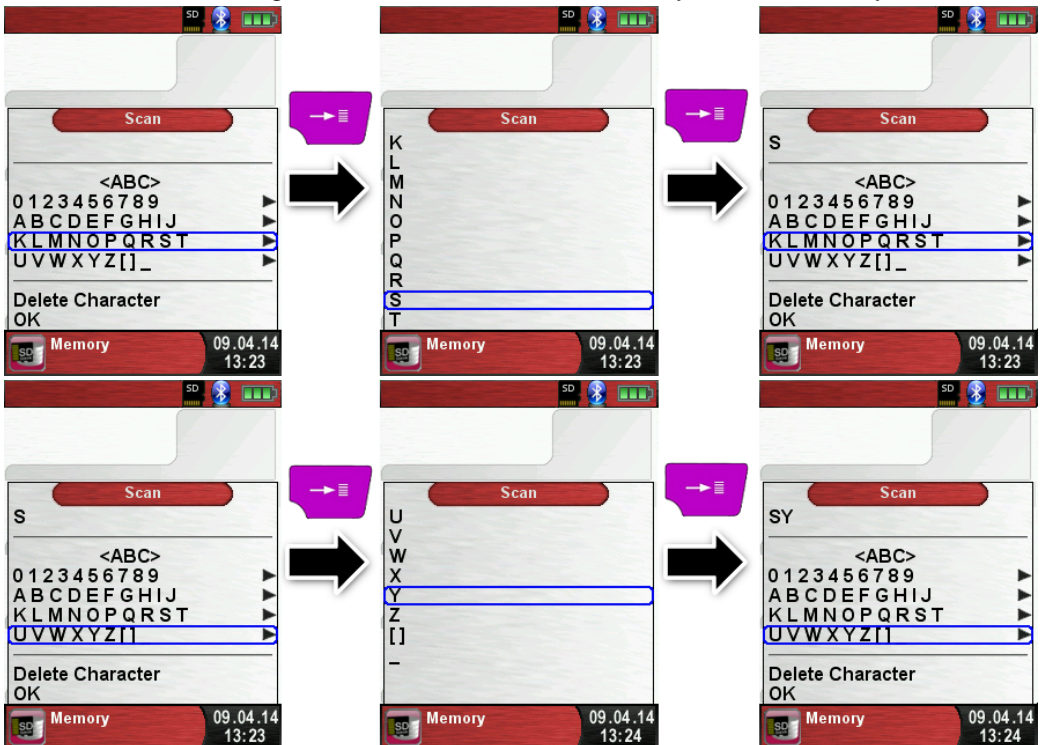

Switch between upper and lower case letters and special characters with „<ABC>“. “Delete character“ will delete the last character. With „OK“ save the customer name. Already existing name will be shown. If the name doesn't exist it is possible to save the customer name with „New entry“.



Now additional information could be saved. (Street, City, Email, and Phone No.):



Select „OK“ to save the individual lines. Finally select “Save changes” to save all customer information.



To delete customers in the database there mustn't be any measurements stored. Select the customer and choose „Scan“, if there are no measurements stored the request „Entry is empty delete?“ will occur. Confirm the request with “Yes“.



► Create / modify customer database on PC

The customer database can be create / modify on the PC as well. Open the file “DATABASE.CSV” on the MicroSD card with the PC. Now type customer information in the table of the “DATABASE.CSV” file. Column A is the customer name and column B – H are for additional customer information. Don't use special characters only „@“, „_“ and „.“. Maximum 20 characters per field.

CAUTION

- ▶ Incorrect editing of the „DATABASE.CSV“ could generate errors in the BLUELYZER® ST.

	A	B	C	D	E
1	SYSTRONIK GmbH	Gewerbestr. 57	88636	Illmensee	
2	Essie	Vaill	Litronic Industries	14225 Hancock Dr	Anchorage
3	Cruz	Roudabush	Meridian Products	2202 S Central Ave	Phoenix
4	Billie	Tinnes	D M Plywood Inc	28 W 27th St	New York
5	Zackary	Mockus	Metropolitan Elevator Co	286 State St	Perth Amboy
6	Rosemarie	Fifield	Technology Services	3131 N Nimitz Hwy -105	Honolulu
7	Bernard	Laboy	Century 21 Keewaydin Prop	22661 S Frontage Rd	Channahon
8	Sue	Haakinson	Kim Peacock Beringhouse	9617 N Metro Pky W	Phoenix
9	Valerie	Pou	Sea Port Record One Stop Inc	7475 Hamilton Blvd	Trexlertown
10	Lashawn	Hasty	Kpff Consulting Engineers	815 S Glendora Ave	West Covina
11	Marianne	Farman	Albers Technologies Corp	6220 S Orange Blossom Trl	Orlando

Finally save the „DATABASE.CSV“ and restart the BLUELYZER® ST before import the MicroSD card. In this way the database will be newly read.

- ▶ Use of the memory

The memory structure consists of 1,000 memory entries (customer or location), within every entry 10 measurements protocols can be stored. In total 10,000 measurements can be stored.

At the end of a measurement you can take the measurement protocol in a free space. The file name is automatically assigned by the device and is structured as follows:

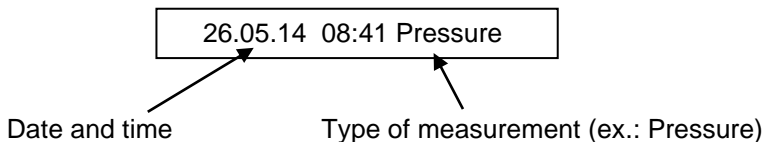
**CAUTION**

A file which has been created and saved on the card is protected against manipulation and, if manipulated, can neither be displayed by the device nor printed!

You can view the saved file, print or override it with a new measurement.



The file name and the storage location is shown in the lower bar. In this example: Storage folder: MEMORY/0000 and file name 0000_00.txt:



The customer information will be shown in the header of the measurement report.

The saved file can be opened with a web browser (e.g.: Chrome, Firefox, Explorer, Opera, etc.)



8.3 Enter the user's address

To Import the user's address you have to create the file "Address.txt" on the MicroSD-card. This is a pure text file with the file extension .txt. The text file can be created with any editor (ex: Notepad) on a PC. A maximum of 8 lines per 22 characters are possible.

Note: An already imported user's address will be overridden!

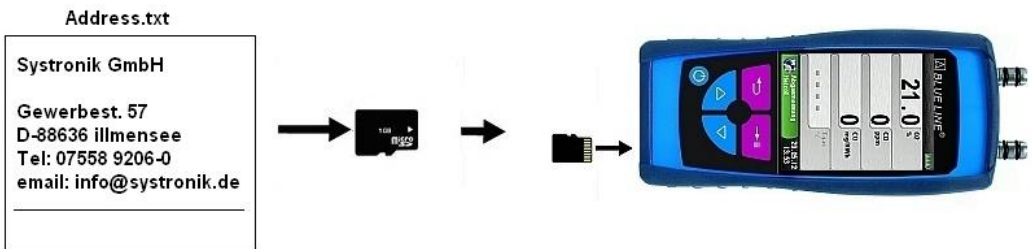

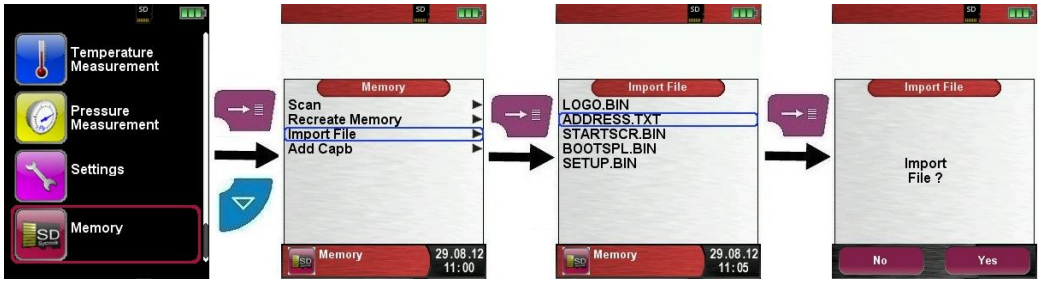

Systronik GmbH
Gewerbest. 57
D-88636 Illmensee
Tel: 07558 9206-0
email: info@systronik.de

Device BLUELYZER
Device Nr. 01-65-0000

Flue gas measurement
Fuel: Natural gas

9 Battery management

9.1 Battery mode/charging mode

- Battery mode: The battery life in continuous measurement depends on the selected display mode. The Display mode "Normal" allows a continuous measurement of up to 8 hours, the mode "Automatic" up to 10 hours and at the mode "Eco Mode" is a continuous measurement of up to 12 hours possible.
- Charging: External USB power supply unit 100-240 V~/50-60 Hz. Intelligent charging by means of an integrated charger management system.

9.2 Charging the batteries

CAUTION



Damage to the batteries or the device caused by power supply units that are not device-specific.

- ▶ Use only the provided USB power supply unit for charging the batteries.

1. Connect the device-specific USB power supply unit to the mains and the USB power supply unit to the BLUELYZER® ST.

↳ The charging process of the batteries starts automatically:



“Charge Funct.” menu

Green Current battery capacity sector

Button	Function
	Close battery menu.

- ↪ During measurements, the battery is also charged continuously and monitored by the system.
- ↪ As soon as the battery is fully charged and the “Charge Funct.” menu is shown the device switches off automatically, otherwise it switches to passive recharging mode (trickle charging). The “Charge Funct.” menu is no longer shown.
- ↪ When recharging is finished the charger can remain connected to the BLUELYZER® ST without the battery being damaged.

Service life and capacity of the battery

The BLUELYZER® ST is equipped with a powerful Li-Ion battery. The service life and capacity of the battery are considerably affected by the way the device is charged and used. In order to make handling safer, the device features efficient and battery-saving charge management suitable for all applications.

The graphical charge level indicator of the BLUELYZER® ST consisting of three elements of a battery symbol helps the user to correctly estimate the capacity of the battery. Five different battery states are detected.

- ▶ During normal use it is recommended not to recharge the battery until it is run down completely.

The battery can be recharged at any time given that the charge management system recognises the need to recharge the battery. Otherwise, the charge management system will not release the battery for charging.

The service life of the Li-Ion battery is significantly reduced when the device is operated at temperatures below +5 °C.

10 Maintenance

Gas treatment, refer to fig. 9, page 67.

- ▶ Empty the condensate trap completely after each operation. Water in the measuring device will destroy pumps and sensors.
- ▶ Check the fine filter for pollution and replace as necessary.
- ▶ If pump capacity is reduced, carefully replace the Teflon membrane filter. Damage to the filter membrane greatly decreases or eliminates the filter function and leads to the failure of expensive pumps and sensors.
- ▶ Make sure threaded parts are straight when positioned and tighten them moderately. Ensure sufficient sealing by means of O rings.
- ▶ Hard-to-move/plug parts (plug-type elements and flanges): Remove any gas residues and grease with Vaseline.

Replacing the battery

For technical reasons, old batteries may only be replaced by the manufacturer or an authorised service partner.



- ▶ Do not short-circuit connection terminals.
- ▶ To protect the environment, batteries must not be disposed of together with the normal household waste. Return old batteries to the point of purchase or to a collecting point.

11 Troubleshooting

Repairs may only be performed by specially trained, qualified staff.

Table 6: Troubleshooting

Problem	Possible reason	Repair
Device automatically switches off.	Battery empty.	▶ Charge battery.
	Battery defective.	▶ Take device to service centre.
O ₂ error message.	Repeated signal error.	▶ Run device without accessories in fresh air
	Service life of O ₂ sensor expired.	▶ Take device to service centre.
"CO value too high"/"CO sensor defective" message.	CO sensor malfunction.	▶ Run device without accessories in fresh air.
	CO measuring range exceeded.	
	End of service life of sensor.	▶ Take device in for servicing.
Incorrect measured gas values (e.g. measured O ₂ value too high, CO ₂ value too low, no CO values displayed, etc.).	Leak in measuring system.	▶ Check gas treatment system for cracks and other damage.
		▶ Check hose system for cracks and other damage.
		▶ Check O rings of gas treatment unit.
		▶ Check O ring of external probe pipe.

Problem	Possible reason	Repair
Service message.	Device has not been inspected for a longer period.	▶ Take device in for servicing.
Measured gas values are displayed slowly.	Filter in the gas treatment system is used up.	▶ Check filter and replace, if necessary.
	Hose system bent.	▶ Check hose system
	Gas pump polluted.	▶ Take device to service centre.
Flue gas temperature unstable.	Humidity in the probe pipe.	▶ Clean probe.
Device does not switch on.	Battery empty.	▶ Charge battery. ▶ Take device to service centre.
Other malfunctions	–	▶ Send the device to the manufacturer.

12 Shutting down and disposal



- ▶ To protect the environment, this device must not be disposed of together with the normal household waste. Dispose of the device according to the local conditions and directives.

This device consists of materials that can be reused by recycling firms. The electronic inserts can be easily separated and the device consists of recyclable materials.

If you do not have the opportunity to dispose of the used device in accordance with environmental regulations, please contact us for possibilities to return it.

13 Spare parts and accessories

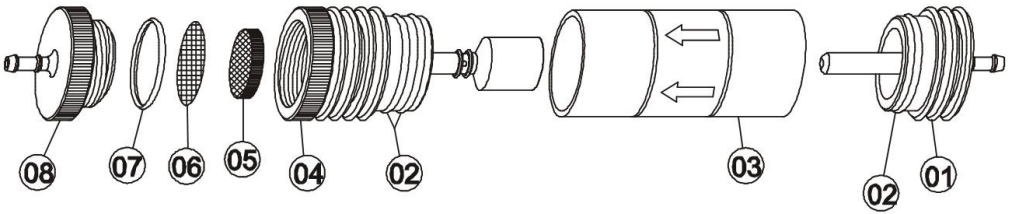

Fig 9: Gas treatment – condensate cartridge

Part	Part no.
Condensate cartridge	500192
Spare parts for condensate cartridge:	
(1) Inlet piece	520594
(2) O ring 23 x 2	520370
(3) Glass piston with arrow	520596
(4) Centre piece with cylinder pieces	522183
(5) Infiltec fine filter, 5 pieces	522165
(6) Filter 23,5 mm	520921
(7) O-Ring 18 x 3	520365
(8) Outlet piece	520591

ACHTUNG



- Prove the functionality of the filters, o rings and glass piston. Disconnect the probe from the device after measurement, take out the condensate and replace if necessary the consumed filters!

14 Warranty

The manufacturer's warranty for this product is 12 months after the date of purchase. This warranty shall be good in all countries in which this device is sold by the manufacturer or its authorised dealers.

15 Copyright

The manufacturer retains the copyright to this manual. This manual may not be reprinted, translated, copied in part or in whole without prior written consent.

We reserve the right to technical modifications with reference to the specifications and illustrations in this manual.

16 Customer satisfaction

Customer satisfaction is our prime objective. Please get in touch with us if you have any questions, suggestions or problems concerning your product.

17 Addresses

The addresses of our worldwide representations and offices can be found on the Internet at www.systronik.com

18 Appendix

18.1 DIN EN 50379 Certificate

ZERTIFIKAT

◆ CERTIFICADO

◆ СЕРТИФИКАТ

◆ 認証証書

◆ CERTIFICATE

◆ ZERTIFIKAT

ZERTIFIKAT
Certificate

Industrie Service

08 12 90217 016

Hiermit wird bescheinigt, dass das
Herewith we certify, that the

**tragbare elektrische Gerät zur Messung
von Verbrennungsparametern an Heizungsanlagen, Typ**
*portable electrical apparatus, designed to measure
combustion flue gas parameters of heating appliance, type*

Bluelyzer ST

mit den Messparametern
for the parameters

O_2/CO_2 , T_{Abgas} , T_{Luft} , **Druck**Förderdruck;
 O_2/CO_2 , $T_{flue\ gas}$, $T_{inlet\ air}$, **pressure** draught

hergestellt durch die Firma
manufactured by

Systronik Elektronik und Systemtechnik GmbH
Gewerbestraße 57
88636 Illmensee

den Anforderungen der folgenden Normen genügt.
fulfils the requirements of the following standards

DIN EN 50379-1:2005-01 und DIN EN 50379-2:2005-01

In Verbindung mit der regelmässigen Überwachung der Fertigung und der QM-Maßnahmen nach der Zertifizierungsordnung der TÜV SÜD Industrie Service GmbH erhält der Hersteller mit diesem Zertifikat das Recht, die Geräte mit dem in diesem Zertifikat dargestellten Zeichen zu kennzeichnen.

In connection with a periodical surveillance of the production and the quality control according the certification regulations of TÜV SÜD Industrie Service GmbH this certificate permits to sign the apparatus with the TÜV mark as shown in this certificate.



München, 2012-08-30

Johannes Steiglechner

TÜV SÜD INDUSTRIE SERVICE GMBH, WESTENDSTRASSE 199, D-80686 MÜNCHEN

TÜV®