

# Thermostat control heads

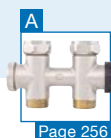

- With liquid probe
- Adjustable eco setting
- Adjustment range can be limited and blocked with ring
- Fits onto many other valve radiators without adapter.



Scale*	Room temperature
❄	Approx. 6 °C (automatic frost protection)
0	Zero end
1	Approx. 14 °C
2	Approx. 17 °C
3	Approx. 20 °C
4	Approx. 23 °C
5	Approx. 26 °C

\* Temperature difference to next dial marks is approx. 3 K

**Application** For setting and controlling the room temperature at the radiator. Version 323 suitable for valve body series Vario, VarioQ, Vario-DP, thermostat combination blocks Vario THK, VarioQ-Kombi and valve radiators with integrated valve insert with connection thread M30 x 1.5 mm. Version 320 suitable for valve versions with Gampper clamp connection (valve bodies up to year of manufacture 1998). Version 323 KD suitable for Danfoss clamp connection (compatible series RA).

**Description** Thermostat control head with liquid probe, consisting of hand wheel with scale and base in different colours (see ordering table). Optional version with remote probe or remote adjustment. The desired room temperature is set with the hand wheel. The temperature probe continuously checks the room temperature, compares the measured values to the set value and controls the flow rate by opening or closing the valve to obtain the set value. Adjustment range can be limited and blocked with a ring. With optimum temperature position (eco position) adjustable via memory clip. Frost protection position with snowflake symbol.

**Tamper-proof version** without zero position. Lower adjustment only to snowflake symbol. The adjustment range must be selected when the valve is mounted for the first time. A protective cap consisting of two parts which cannot be removed prevents disassembly and changes to the selected settings. The protective cap is secured by means of a screw.

## Technical specifications

### Connection valve body

322: Threaded connection M 30 x 1.5 mm

323: Gampper clamp connection

323 KD: Danfoss clamp connection

### Operating temperature range

Ambient:  $T_{max}$  50 °C

### Material

Plastic

### Option

- Personalised labels

### i

Special, customised labels on the thermostat heads are possible for purchase quantities > 100 pieces.

Please note the manufacturer information concerning the connection geometry.

See page 263 for prices.

# Thermostat control heads

## Types and dimensions (mm)

Thermostat control head 323 with fixed probe

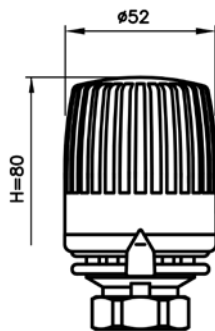

Thermostat control head 323 F with remote probe

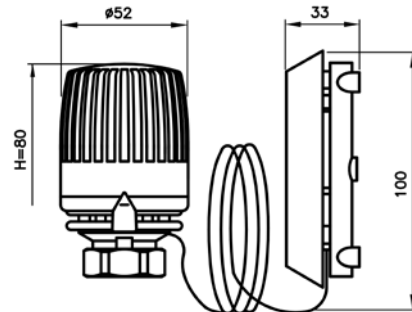

Thermostat control head 323 B with fixed probe, tamper-proof version with anti-theft system

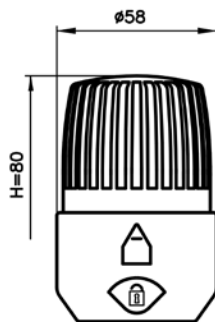

Thermostat control head 323 BF with remote probe, tamper-proof version with anti-theft system

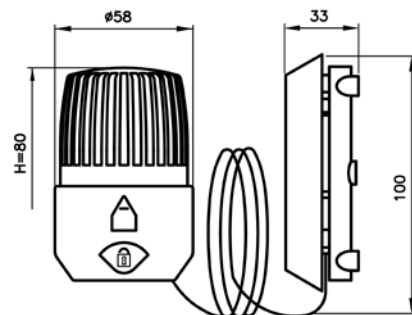

Thermostat control head 320 FV with remote adjustment and remote transmission

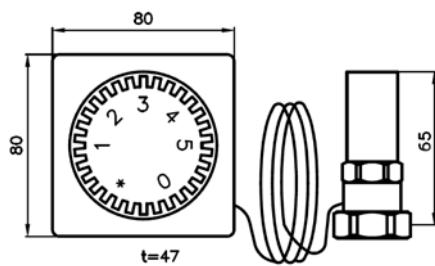

# Thermostat control heads

## Types and dimensions (mm)

Thermostat control head 323 KD with fixed probe, Danfoss clamp connection

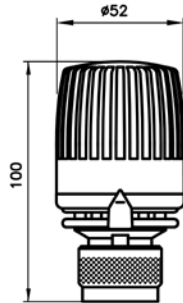

Thermostat control head 323 KD with remote probe, Danfoss clamp connection

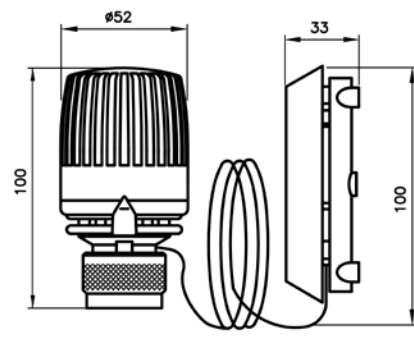

Thermostat control head 323 KD FV with remote adjustment and remote probe, Danfoss clamp connection

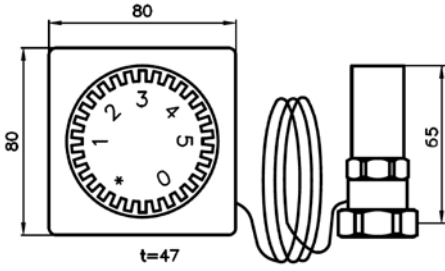



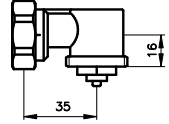





Angle adapter









08

# Thermostat control heads with threaded connection





DG: V, PG: 1	Description	0 setting	Hand wheel/ base	Capillary tube			Part no.	Price €
	<b>Thermostat control head 323</b> With liquid probe, threaded connection M30 x 1.5 mm	With	White/ black	-	1	50	<b>360 002.100</b>	
		Without	White/ black	-	1	-	<b>360 000.100</b>	
	<b>Thermostat control head 323</b> With liquid probe, threaded connection M30 x 1.5 mm	With	White	-	1	-	<b>360 012.100</b>	
		Without	White	-	1	-	<b>360 010.100</b>	
	<b>Thermostat control head 323</b> With liquid probe, threaded connection M30 x 1.5 mm and personalised <b>company label</b>	With	White/ black	-	1	200	360 002.109	<b>On request</b>
		Without	White/ black	-	1	200	360 000.109	<b>On request</b>
	<b>Thermostat control head 323 F</b> With remote probe and bracket, threaded connection M30 x 1.5 mm	With	White/ black	1.2 m	1	-	362 102.100	
		With	White/ black	2 m	1	30	<b>362 202.100</b>	
		With	White	1.2 m	1	-	362 112.100	
		With	White	2 m	1	-	362 212.100	
		Without	White/ black	1.2 m	1	-	362 100.100	
		Without	White/ black	2 m	1	-	362 200.100	
		Without	White	1.2 m	1	-	362 110.100	
Without	White	2 m	1	-	362 210.100			
	<b>Thermostat control head 323 B</b> Tamper-proof version with anti-theft system, threaded connection M30 x 1.5 mm	Without	White/ black	-	1	30	<b>364 000.100</b>	
	<b>Thermostat control head 320 FV</b> With remote adjustment and remote transmission, threaded connection M30 x 1.5 mm	With	White	2 m	1	12	347 200.100	

# Thermostat control heads with clamp connection: Gampper, Danfoss

DG: V, PG: 1	Description	0 setting	Hand wheel/ base	Capillary tube			Part no.	Price €
	<b>Thermostat control head 323</b> with liquid probe, Gampper clamp connection.  For valves from 1980 - 1998 (and replacement for models 313, 314, 320)	With	White/ black	-	1	50	<b>360 002</b>	
		Without	White/ black	-	1	50	360 000	
	<b>Thermostat control head 323 F N</b> with remote probe and bracket, Gampper clamp connection.  For valves from 1980 - 1998 (and replacement for models 313, 314, 320)  Replacement for thermostat control heads series 312 up to 1980	With	White/ black	1.2 m	1	30	362 102	
		With	White/ black	2 m	1	30	<b>362 202</b>	
	<b>Thermostat control head 323 KD</b> with liquid probe, Danfoss clamp connection, compatible series RA	With	White/ black	-	1	15	360 002.130	
	<b>Thermostat control head 323 KD F</b> with remote probe, Danfoss clamp connection, compatible series RA	With	White/ black	2 m	1	-	362 202.130	
	<b>Thermostat control head 320 KD FV</b> with remote adjustment and remote transmission, Danfoss clamp connection, compatible series RA	With	White	2 m	1	-	347 200.130	

8

## Accessories for thermostat control heads

DG: V, PG: 1	Description			Part no.	Price €
	<b>Angle adapter</b> M30 x 1.5 mm, white	1	-	340 010.200	
	<b>Tamper-proof cap 323 BK</b> for control heads 323	1	-	364 110	