

Dynamic thermostat valve bodies, combination blocks Vario-DP



- Automatic control of water volume
- Fast hydraulic balancing without measuring instrument
- High reserve due to adjustment range up to 340 l/h
- Patented, simple valve insert provides protection against pollution



Application The new dynamic thermostat valve Vario-DP makes hydraulic balancing in single and two family homes an easy and fast job.

Description The patented valve insert with automatic flow limiter automatically limits the water volume adjusted at the valves, independent of pressure variation in the heating system. Therefore, Vario-DP ensures that the right water volume is always supplied to the radiator, regardless of the number of open or closed thermostat valves in the system.

Vario-DP is available in the standard types angled, straight, axial and Wangled-angled with the dimensions $\frac{3}{8}$ ", $\frac{1}{2}$ " and $\frac{3}{4}$ " as well as thermostat combination block. The valve insert can be replaced with the MGV mounting unit at operating pressure without the system having to be drained.

Technical specifications

System connection

See ordering table

Thermostat head/actuator connection

Threaded connection M 30 x 1.5 mm

Nominal pressure

Max. 10 bar

Differential pressure (Δp)

Max. 50 kPa

Min.: 20 kPa

Nominal diameter

DN 10, DN 15, DN 20

Operating temperature range

Medium: $T_{max} = 120$ °C

Housing

Gunmetal, nickel-plated



See page 248 for prices.

Please note the additional information on valve selection (water volume) and mounting in the operating instructions.

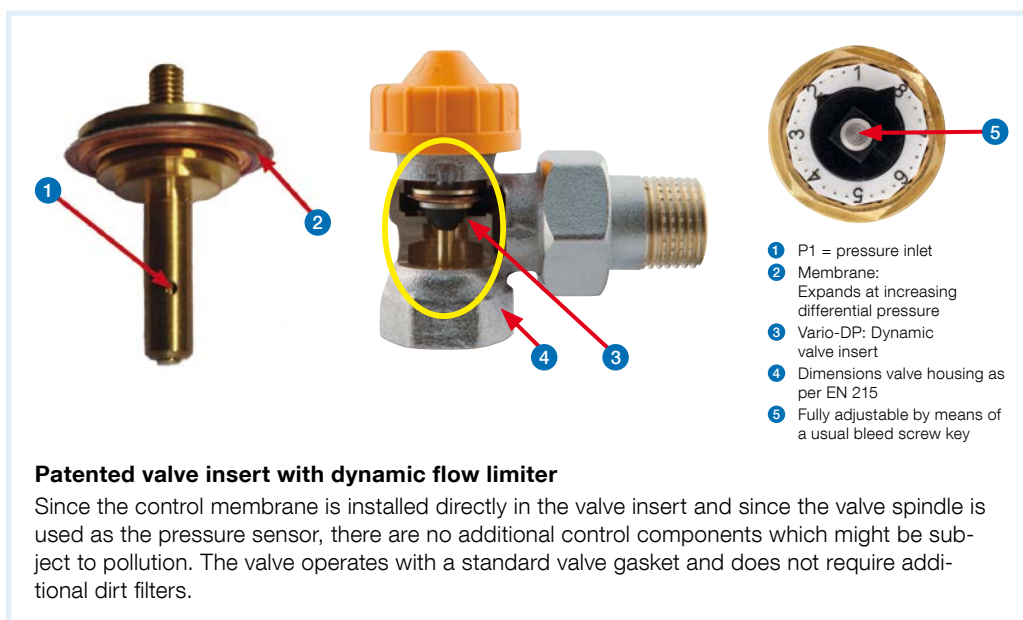

Dynamic thermostat valve bodies

Vario-DP

Types and dimensions (mm)

Vario-DP – angled

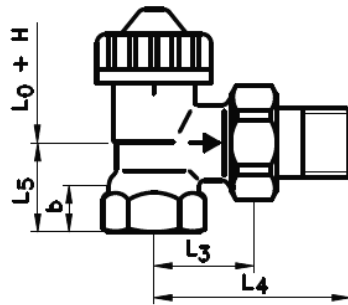

Vario-DP – straight

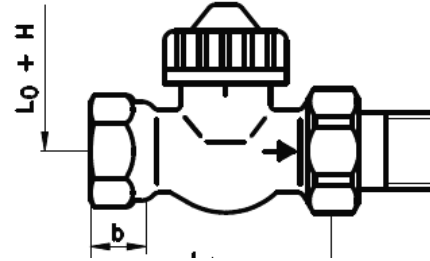

Vario-DP – axial

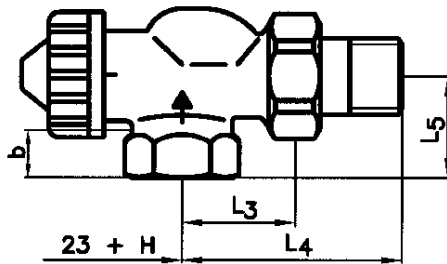

Vario-DP – angled-angled, left

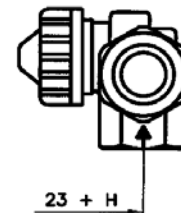

Vario-DP – angled-angled, right

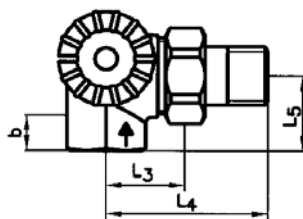

Dimensions (mm) Vario-DP

DN	D	B	L0	L1	L2	L3	L4	L5	L6
10	Rp ^{3/8}	10.1	23	59	85	26	52	25	-
15	Rp ^{1/2}	13.2	23	66	95	29	58	26	55
20	Rp ^{3/4}	14.5	23	74	106	34	66	29	-

Dynamic thermostat combination blocks Vario-DP

Types and dimensions (mm)



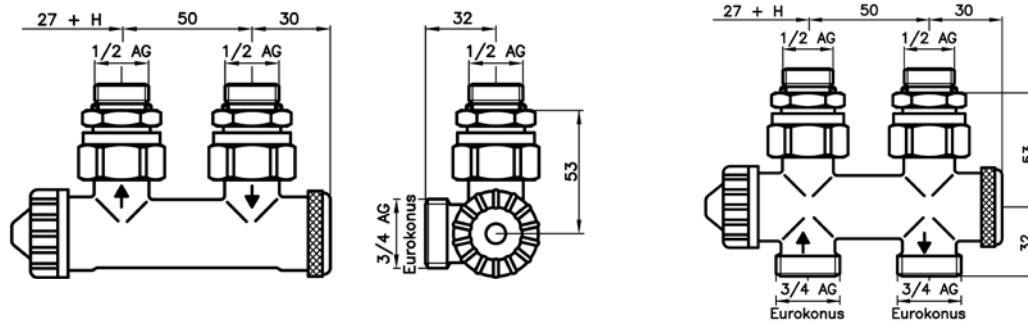



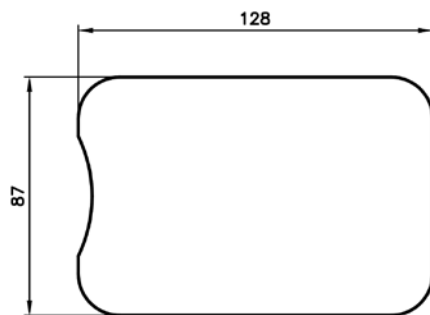

Version for compact radiators/bathroom radiators with G $\frac{1}{2}$ female thread



Cover



Dynamic thermostat valve bodies, combination blocks Vario-DP

DG: V, PG: 2		Connection	Part no.	Prices €
<p>Thermostat valve body Vario-DP, pressure-independent thermostat valve with automatic flow limiter automatically maintains the adjusted water volume, control range 20–50 kPa, static below 20 kPa, adjustment range 20–340 l/h, continuously adjustable with standard vent key, housing gunmetal, nickel-plated, PN 10, max. temperature 120 °C, with threaded connection M 30 x 1.5 mm, valve spindle with double O ring seal, sealing element maintenance-free, with mounting cap. Valve insert can be replaced at operating pressure without the system having to be drained.</p>				
	Angled	Rp ³ / ₈ x R ³ / ₈	161 010.100	
		Rp ¹ / ₂ x R ¹ / ₂	161 020.100	
		Rp ³ / ₄ x R ³ / ₄	161 030.100	
	Straight	Rp ³ / ₈ x R ³ / ₈	161 060.100	
		Rp ¹ / ₂ x R ¹ / ₂	161 070.100	
		Rp ³ / ₄ x R ³ / ₄	161 080.100	
	Axial	Rp ¹ / ₂ x R ¹ / ₂	163 020.100	
	Winkel-Eck, rechts	Rp ¹ / ₂ x R ¹ / ₂	165 020.100	
	Winkel-Eck, links	Rp ¹ / ₂ x R ¹ / ₂	167 020.100	
<p>Thermostat combination block Vario-DP, for radiators with centre connection in dual-pipe system, valve insert with dynamic flow limiter, pressure-independent thermostat valve automatically maintains the adjusted water volume, control range 20–50 kPa, static below 20 kPa, adjustment range 20–340 l/h continuously adjustable with standard vent key, pre-adjustment immediately readable without scale, brass housing, nickel-plated, PN 10, max. temperature 120 °C, valve spindle with double O ring seal, low-noise, threaded connection M 30 x 1.5 mm, brass shut-off spindle, connections at pipe and with 3/4" eurocone.</p>				
Version for compact radiators/bathroom radiators with G ¹ / ₂ female thread				
	Straight	G ¹ / ₂ female thread	221 075.100	
	Angled	R ¹ / ₂ female thread	221 025.100	
Accessories				
	Valve insert, for thermostat valve bodies of series Vario DP Connection: Rp ³ / ₈ x R ³ / ₈ and R ¹ / ₂ x R ¹ / ₂	R ³ / ₈ "–3/4"	160 020.211	