

# Gas filled thermometers for chemical applications



- For chemical, process engineering and food industry applications
- High measuring accuracy
- Fast response



Page 285

4

**Application** For corrosive media. Meets the most exacting measuring demands, e.g. in process engineering as well as chemical and food industry applications.

## Technical specifications

### Type

D4

### Nominal size

100 – 160

### Measuring principle

Pressurised gas filling

### Accuracy class

1 (EN 13190)

### Ranges °C

-20/+60, 0/60, 0/120, 0/160, 0/200, 0/300, 0/400, 0/500

## Standard version

### Connection

Stem stainless steel 321,  
100 x 10 mm, plain

### Mounting position

Centre back or bottom or with joint

### Dial

Aluminium, white  
Dial marking black

### Pointer

Aluminium, black

## Options

- Every angle version
- Grooved nut connection as per DIN 11851
- Other connection designs
- Other nominal sizes
- Other ranges
- Special scales

## Application area

Continuous: Full scale value

Short-term: 1.1 x full scale value

## Operating pressure at thermowell

Max. 10 bar (up to 300 °C)

## Degree of protection

IP 65 (EN 60529)

## Zero correction

At side of housing

## Movement

Brass

## Housing

Stainless steel 304

## Bayonet type bezel

Stainless steel 304

## Window

Instrument glass

- Glycerine filling (type D8)
- 3-hole fixing, panel mounting bezel
- Back flange
- Capillary (stainless steel 321)
- Special materials
- Electrical contacts



See page 280 for prices.

# Gas filled thermometers for chemical applications

Type D4 – NG 100 / 160

## Housing types and dimensions (mm)

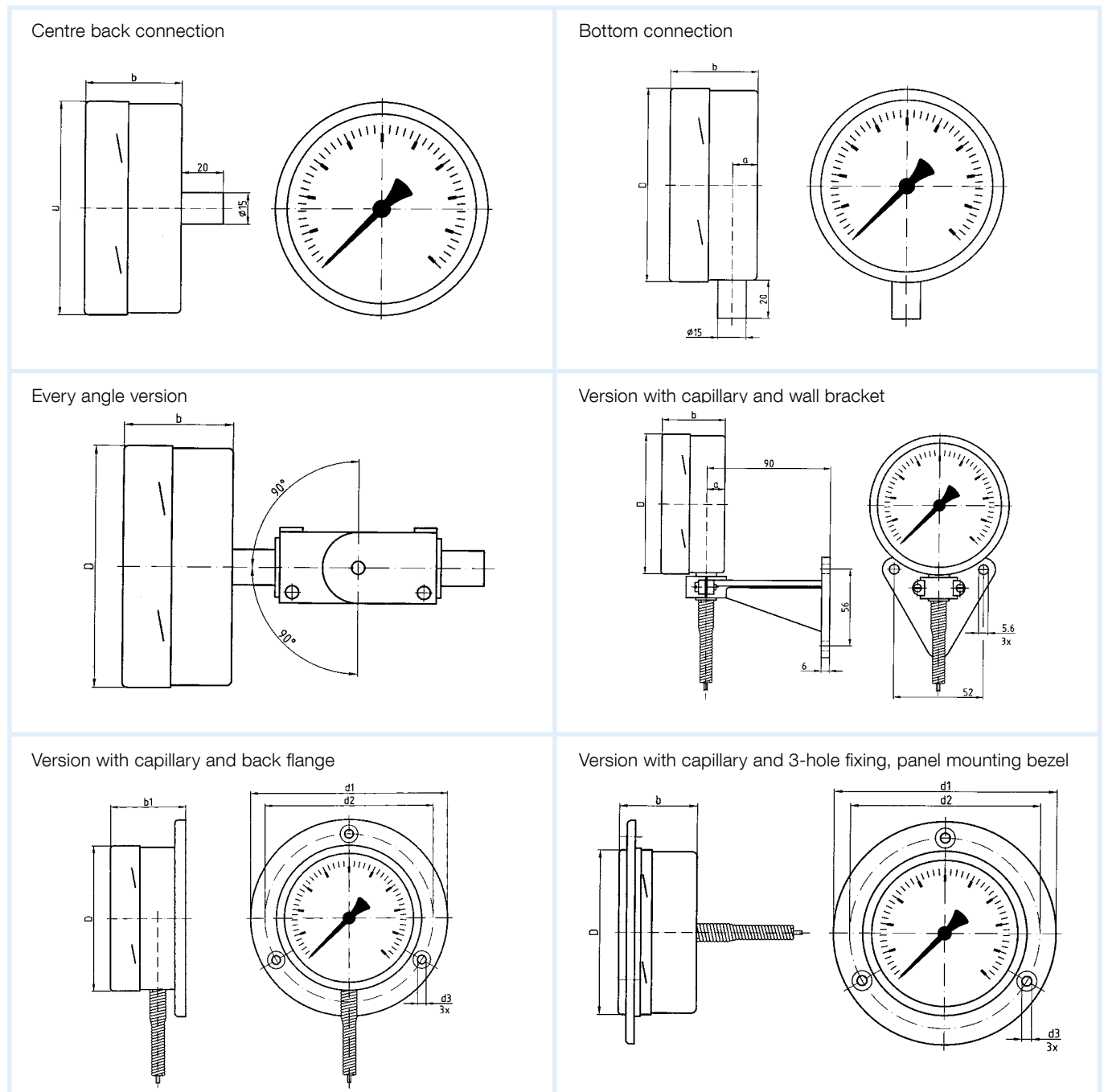



## Dimensions (mm)

Nominal size	a	b	b <sub>1</sub>	Ø D	Ø d <sub>1</sub>	Ø d <sub>2</sub>	Ø d <sub>3</sub>
100	13	45	51	101	132	116	5.5
160	13	45	51	161	196	178	6
250	13	55	57	252	285	270	6

# Gas filled thermometers for chemical applications

DG: H, PG: 3

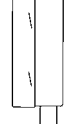
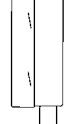
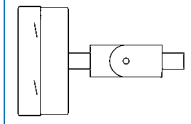
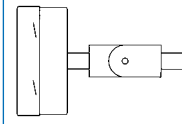
Type	FTh 100 Ch D412	FTh 160 Ch D412	FTh 100 Ch D402	FTh 160 Ch D402	FTh 100 Ch D482	FTh 160 Ch D482
Version						
Housing Ø	100	160	100	160	100	160
Housing	Stainless steel 304 with bayonet bezel, instrument glass window					
Stem	Stainless steel 321, 100 x 10 mm					
Connection	Plain stem (without thermowell)					
Filling	Pressurised gas filling					
Accuracy class	Class 1 as per EN 13190					
					Every angle version	
Range	-20/+60 °C	-20/+60 °C	-20/+60 °C	-20/+60 °C	-20/+60 °C	-20/+60 °C
	<b>Price €</b> Part no.	<b>Price €</b> Part no.	<b>Price €</b> Part no.	<b>Price €</b> Part no.	<b>Price €</b> Part no.	<b>Price €</b> Part no.
	64341412	64343412	64341402	64343402	64341482	64343482
Range	0/60 °C	0/60 °C	0/60 °C	0/60 °C	0/60 °C	0/60 °C
	<b>Price €</b> Part no.	<b>Price €</b> Part no.	<b>Price €</b> Part no.	<b>Price €</b> Part no.	<b>Price €</b> Part no.	<b>Price €</b> Part no.
	64361412	64363412	64361402	64363402	64361482	64363482
Range	0/120 °C	0/120 °C	0/120 °C	0/120 °C	0/120 °C	0/120 °C
	<b>Price €</b> Part no.	<b>Price €</b> Part no.	<b>Price €</b> Part no.	<b>Price €</b> Part no.	<b>Price €</b> Part no.	<b>Price €</b> Part no.
	64373412	64375412	64373402	64375402	64373482	64375482
Range	0/160 °C	0/160 °C	0/160 °C	0/160 °C	0/160 °C	0/160 °C
	<b>Price €</b> Part no.	<b>Price €</b> Part no.	<b>Price €</b> Part no.	<b>Price €</b> Part no.	<b>Price €</b> Part no.	<b>Price €</b> Part no.
	64377412	64379412	64377402	64379402	64377482	64379482
Range	0/200 °C	0/200 °C	0/200 °C	0/200 °C	0/200 °C	0/200 °C
	<b>Price €</b> Part no.	<b>Price €</b> Part no.	<b>Price €</b> Part no.	<b>Price €</b> Part no.	<b>Price €</b> Part no.	<b>Price €</b> Part no.
	64381412	64383412	64381402	64383402	64381482	64383482
Range	0/300 °C	0/300 °C	0/300 °C	0/300 °C	0/300 °C	0/300 °C
	<b>Price €</b> Part no.	<b>Price €</b> Part no.	<b>Price €</b> Part no.	<b>Price €</b> Part no.	<b>Price €</b> Part no.	<b>Price €</b> Part no.
	64389412	64391412	64389402	64391402	64389482	64391482
Range	0/400 °C	0/400 °C	0/400 °C	0/400 °C	0/400 °C	0/400 °C
	<b>Price €</b> Part no.	<b>Price €</b> Part no.	<b>Price €</b> Part no.	<b>Price €</b> Part no.	<b>Price €</b> Part no.	<b>Price €</b> Part no.
	64397412	64399412	64397402	64399402	64397482	64399482
Range	0/500 °C	0/500 °C	0/500 °C	0/500 °C	0/500 °C	0/500 °C
	<b>Price €</b> Part no.	<b>Price €</b> Part no.	<b>Price €</b> Part no.	<b>Price €</b> Part no.	<b>Price €</b> Part no.	<b>Price €</b> Part no.
	64401412	64403412	64401402	64403402	64401482	64403482

Blue part no. = in-stock items



\* See page 283 for other connection types, options/extra charges.

# Gas filled thermometers for chemical applications

DG: H, PG: 3

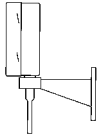
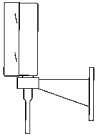
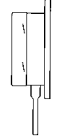
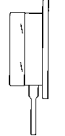
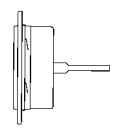
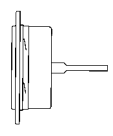
Type	FTh 100 Ch D442	FTh 160 Ch D442	FTh 100 Ch D472	FTh 160 Ch D472	FTh 100 Ch D432	FTh 160 Ch D432
Version						
Housing Ø	100	160	100	160	100	160
Housing	Stainless steel 304 with bayonet bezel, instrument glass window					
Stem	Stainless steel 321, 100 x 10 mm					
Connection	Plain stem (without thermowell)					
Filling	Pressurised gas filling					
Capillary	Stainless steel 321, 1 metre					
Mounting	Wall bracket		Back flange		3-hole fixing, panel mounting bezel, 304	
Accuracy class	Class 1 as per EN 13190					
Range	-20/+60 °C	-20/+60 °C	-20/+60 °C	-20/+60 °C	-20/+60 °C	-20/+60 °C
	<b>Price €</b> Part no.	<b>Price €</b> Part no.	<b>Price €</b> Part no.	<b>Price €</b> Part no.	<b>Price €</b> Part no.	<b>Price €</b> Part no.
	64341442	64343442	64341472	64343472	64341432	64343432
Range	0/60 °C	0/60 °C	0/60 °C	0/60 °C	0/60 °C	0/60 °C
	<b>Price €</b> Part no.	<b>Price €</b> Part no.	<b>Price €</b> Part no.	<b>Price €</b> Part no.	<b>Price €</b> Part no.	<b>Price €</b> Part no.
	64361442	64363442	64361472	64363472	64361432	64363432
Range	0/120 °C	0/120 °C	0/120 °C	0/120 °C	0/120 °C	0/120 °C
	<b>Price €</b> Part no.	<b>Price €</b> Part no.	<b>Price €</b> Part no.	<b>Price €</b> Part no.	<b>Price €</b> Part no.	<b>Price €</b> Part no.
	64373442	64375442	64373472	64375472	64373432	64375432
Range	0/160 °C	0/160 °C	0/160 °C	0/160 °C	0/160 °C	0/160 °C
	<b>Price €</b> Part no.	<b>Price €</b> Part no.	<b>Price €</b> Part no.	<b>Price €</b> Part no.	<b>Price €</b> Part no.	<b>Price €</b> Part no.
	64377442	64379442	64377472	64379472	64377432	64379432
Range	0/200 °C	0/200 °C	0/200 °C	0/200 °C	0/200 °C	0/200 °C
	<b>Price €</b> Part no.	<b>Price €</b> Part no.€	<b>Price €</b> Part no.	<b>Price €</b> Part no.	<b>Price €</b> Part no.	<b>Price €</b> Part no.
	64381442	64383442	64381472	64383472	64381432	64383432
Range	0/300 °C	0/300 °C	0/300 °C	0/300 °C	0/300 °C	0/300 °C
	<b>Price €</b> Part no.	<b>Price €</b> Part no.	<b>Price €</b> Part no.	<b>Price €</b> Part no.	<b>Price €</b> Part no.	<b>Price €</b> Part no.
	64389442	64391442	64389472	64391472	64389432	64391432
Range	0/400 °C	0/400 °C	0/400 °C	0/400 °C	0/400 °C	0/400 °C
	<b>Price €</b> Part no.	<b>Price €</b> Part no.	<b>Price €</b> Part no.	<b>Price €</b> Part no.	<b>Price €</b> Part no.	<b>Price €</b> Part no.
	64397442	64399442	64397472	64399472	64397432	64399432
Range	0/500 °C	0/500 °C	0/500 °C	0/500 °C	0/500 °C	0/500 °C
	<b>Price €</b> Part no.	<b>Price €</b> Part no.	<b>Price €</b> Part no.	<b>Price €</b> Part no.	<b>Price €</b> Part no.	<b>Price €</b> Part no.
	64401442	64403442	64401472	64403472	64401432	64403432

Blue part no. = in-stock items



\* See page 283 for other connection types, options/extra charges.