

Bimetal thermometers for industrial applications

Bimetal air duct thermometers



4

Bimetal thermometers for industrial applications

Technical specifications

Mechanical engineering, plant engineering, pipelines, boilers, heating technology

Type
D2

Nominal size
63 – 80 – 100 – 160

Measuring element
Bimetal helix

Accuracy class
1 (EN 13190)

Ranges °C
-20/+60, 0/60, 0/120, 0/160

Application area (EN 13190)
Continuous load: measuring range
Short-term: range

Operating pressure at thermowell
Max. 6 bar

Degree of protection
IP 41 (EN 60529)

Standard version

Connection
Stem brass, Ø 9 mm
Thermowell G½B, brass, removable

Mounting position
NG 63 – 80 – 100 – 160 centre back
NG 63 – 80 – 100 – 160 bottom

Dial
Aluminium, white,
Dial marking black

Pointer
Aluminium, black

Housing
Sheet steel galvanised

Push on bezel
Sheet steel nickel-plated

Window
Instrument glass

Options

- Other connection types
- Other ranges
- Other stem lengths

Bimetal air duct thermometers

Air conditioning, ventilation

Type
D2

Nominal size
63 – 80 – 100

Measuring element
Bimetal helix

Accuracy class
2 (EN 13190)

Ranges °C
-30/+50, -20/+60, -20/+40, 0/60

Application area
Full scale value

Degree of protection
IP 41 (EN 60529)

Connection
Stem brass, Ø 9 mm, mounting flange,
plastic Ø 60 mm, or back flange, steel

Mounting position
NG 63 – 80 – 100 centre back

Dial
Aluminium, white,
Dial marking black

Pointer
Plastic, black

Housing
Sheet steel galvanised

Push on bezel
Sheet steel nickel-plated

Window
Version LKF: Plastic
Version LKB: Instrument glass

- Other ranges
- Other stem lengths
- Accuracy class 1
- Steel flange Ø 40/80 mm



See page 270
for prices.

Bimetal thermometers for industrial applications/ Bimetal air duct thermometers

Housing types and dimensions (mm)

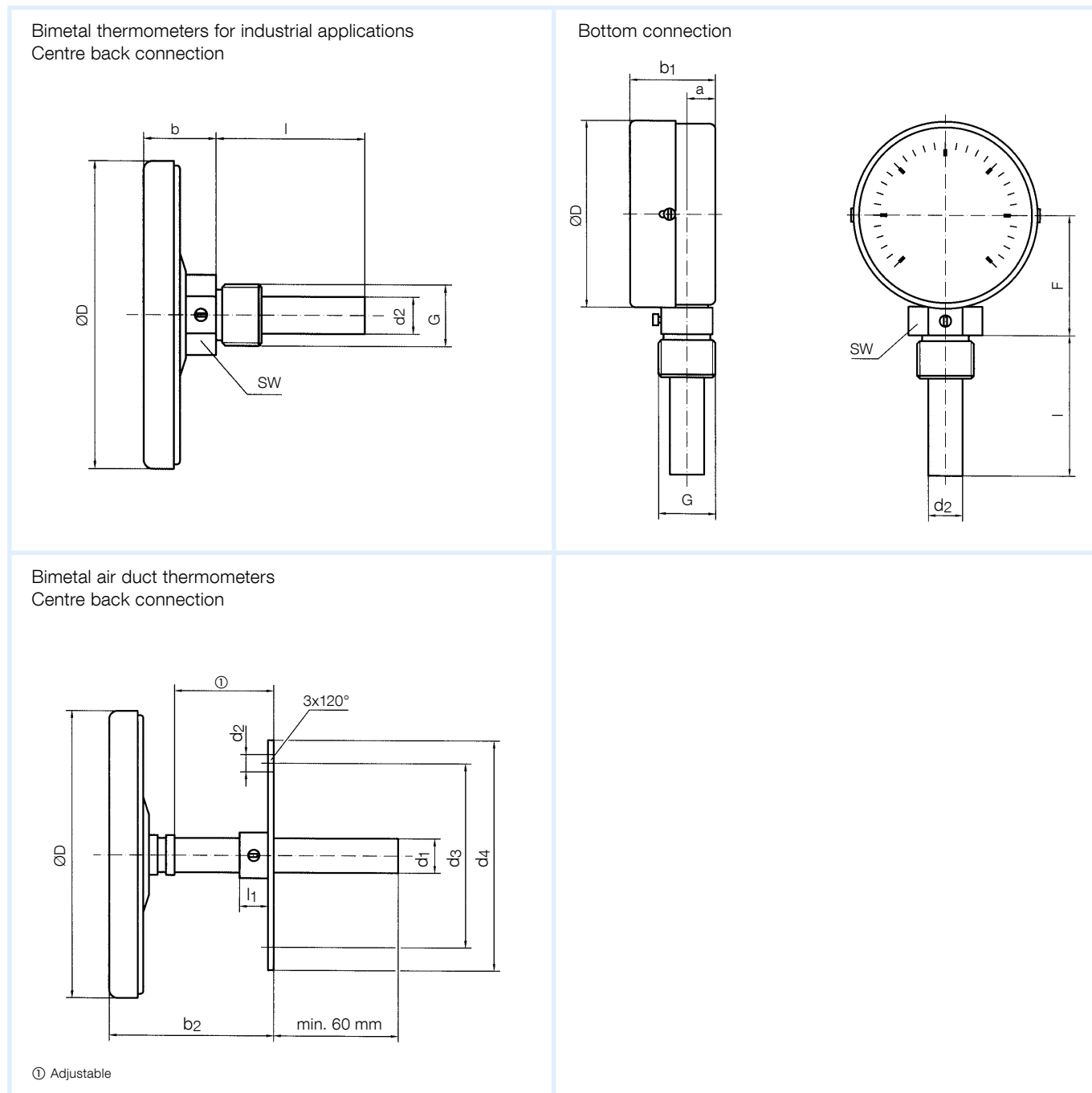

Dimensions (mm)

Nominal size (NG)	a	b	b ₁	b ₂	D	d ₁	d ₂	d ₃	d ₄	F	G	l	l ₁	SW
63	10	24	34	Adjustable	63	9	12	51	60	43,5	G½B	40	10	22
80	10	24	36		80	9	12	51	60	52	G½B	63	10	22
100	10	26	36		100	9	12	51	60	62	G½B	100	10	22
160	-	32	37		160	-	-	-	-	92	G½B	150	-	22

Bimetal air duct thermometers

DG: H, PG: 2

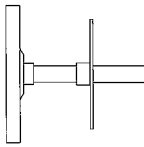
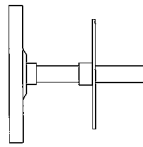
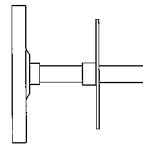
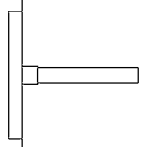
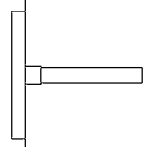
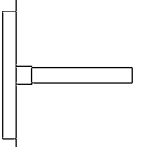
Type	BiTh 63 LKF D211	BiTh 80 LKF D211	BiTh 100 LKF D211	BiTh 63 LKB D271	BiTh 80 LKB D271	BiTh 100 LKB D271
Version						
Housing Ø	63	80	100	63	80	100
Housing	Sheet steel galvanised, push on bezel nickel-plated, plastic window			Sheet steel, galvanised, push on bezel nickel-plated, with back flange, instrument glass window		
Stem	Brass, Ø 9 mm					
Connection	Flange, plastic, Ø 60 mm			plain		
Accuracy class	Class 2 as per EN 13190					
Range	-30/+50 °C	-30/+50 °C	-30/+50 °C	-30/+50 °C	-30/+50 °C	-30/+50 °C
Stem length	Price € Part no.	Price € Part no.	Price € Part no.	Price € Part no.	Price € Part no.	Price € Part no.
100 mm	65613211	65713211	65813211	65613271	65713271	65813271
150 mm	65614211	65714211	65814211	65614271	65714271	65814271
200 mm	65615211	65715211	65815211	65615271	65715271	65815271
Range	-20/+60 °C	-20/+60 °C	-20/+60 °C	-20/+60 °C	-20/+60 °C	-20/+60 °C
Stem length	Price € Part no.	Price € Part no.	Price € Part no.	Price € Part no.	Price € Part no.	Price € Part no.
100 mm	65608211	65708211	65808211	65608271	65708271	65808271
150 mm	65609211	65709211	65809211	65609271	65709271	65809271
200 mm	65610211	65710211	65810211	65610271	65710271	65810271
Range	-20/+40 °C	-20/+40 °C	-20/+40 °C	-20/+40 °C	-20/+40 °C	-20/+40 °C
Stem length	Price € Part no.	Price € Part no.	Price € Part no.	Price € Part no.	Price € Part no.	Price € Part no.
100 mm	65623211	65723211	65823211	65623271	65723271	65823271
150 mm	65624211	65724211	65824211	65624271	65724271	65824271
200 mm	65625211	65725211	65825211	65625271	65725271	65825271
Range	0/60 °C	0/60 °C	0/60 °C	0/60 °C	0/60 °C	0/60 °C
Stem length	Price € Part no.	Price € Part no.	Price € Part no.	Price € Part no.	Price € Part no.	Price € Part no.
100 mm	65633211	65733211	65833211	65633271	65733271	65833271
150 mm	65634211	65734211	65834211	65634271	65734271	65834271
200 mm	65635211	65735211	65835211	65635271	65735271	65835271

Minimum order quantity for non-stock items = 10 pieces

Blue part no. = in-stock items



See page 283 for options/extra charges.